

Operating Manual

for

Liconic

Kiwi

Stores

STT 1k5_V002_MANUAL

KIWI STORE 1k5 ULT

Important Notice

© 2016 LiCONiC AG Liechtenstein, all rights reserved.

The Information contained in this document is subject to change without notice.

Information provided by LiCONiC AG is believed to be accurate and reliable. However, the user is responsible for the proper and correct use of the product. No license is granted by acquisition of the product for any patent or patent rights of LiCONiC. If the user does not follow the instructions given in this manual, LiCONiC does not take any responsibility for injuries or damages caused by the LiCONiC product.

Contact Address

LiCONiC AG
Industriestrasse 8
FL - 9493 Mauren
Principality of Liechtenstein

Telephone: +423 373 63 39
Telex: +423 373 53 59
E-mail: info@liconic.com
Internet: www.liconic.com

Before operating the instrument, the user must read and understand this manual.

Installation and Servicing

Installation, servicing and reinstallation of the instrument shall only be performed by System Integrators and / or service personnel authorized by LiCONiC AG.

LiCONiC regularly offers Operator Training Courses. We highly recommend the attendance of such a course prior to working with a LiCONiC Instrument.

Table of Contents

Introduction	6
1. About the Product and its Manual.....	6
1.1 Intended Use	6
1.2 Unintended Use	6
1.3 Product Identification	6
1.4 Scope of Delivery.....	6
1.5 General	7
1.6 Definitions	7
1.7 Target User Group.....	7
1.8 Importance of the Safety Instructions	7
1.9 Labels	8
1.10 Safety - Basics.....	8
1.10.1 General Operating Hazards	8
1.10.2 Mechanical Hazards	8
1.10.3 Electrical Hazards.....	8
1.10.4 Chemical, Biological and Radioactive Hazards	8
1.10.5 Extreme Temperature Hazards.....	9
1.10.6 Suffocation Hazard.....	9
1.11 General Safety Regulations.....	9
1.11.1 Legal Requirements.....	9
1.11.2 General Inspection and Maintenance Duties	9
1.11.3 Spare Parts to be used.....	9
1.11.4 Modifications.....	9
General.....	10
2. The Kiwi Store Family	10
2.1 Kiwi Store.....	10
2.2 Kiwi Store STT 1k5 ULT Features.....	10
2.3 Kiwi Store STT 1k5 ULT Capacity Examples	11
Options	13
3. Climate of LiCONiC Kiwi Stores	13
3.1 Overview	13
3.2 Cooling.....	13
3.3 Temperature	13
3.4 Humidity	13
4. Backup solutions for Kiwi Stores	14
4.1 Overview	14
4.2 CO2 Backup cooling for temperatures above – 75°C	14
4.3 LN2 Backup cooling.....	15
5. Identification	16
5.1 Barcode reader	16
5.1.1 Supported Barcode Types.....	16
5.1.2 Barcode Specifications	16
5.2 2D Code rack scanner.....	17
5.2.1 Supported 2D code Types	17
5.2.2 2D code scanner Specifications.....	17
Accessories	18
6. Transfer Stations.....	18
6.1 Standard Transfer Station for STT1k5 ULT.....	18
6.2 Standard Transfer nest.....	18
6.3 Transfer nest Sensor	18
7. Kiwi Store Cassettes for STT 1k5 ULT	19
Installation	20
8. KiWi Store STT installation.....	20
8.1 3D-View	20
8.2 Top view	20

8.3	Panel Locations	21
8.4	General Requirements	22
8.5	Clearance Requirements	22
8.6	Refrigeration Elements Overview	23
8.7	Electrical Refrigeration Principles	23
8.8	Cold Water Cooler	24
8.9	Typical Water Cooler Integration	25
8.10	STT Cooling Water Connection	26
8.11	Requirements Cooling Water	27
8.12	LN2 Backup Connections	28
8.13	LN2 Requirements	28
8.14	Electrical Overview	29
8.15	Electrical Connections System	29
8.16	Electrical Connections Cooling unit	30
8.17	Electrical Connections Interface	31
8.18	Electrical Requirements	32
8.19	Gassing Installation	33
8.19.1	Kiwi Store Gassing and Backup Options	33
8.19.2	Safety Information	33
8.19.3	Installation Safety Recommendations	35
8.19.4	Gassing System Installation	38
8.19.5	Specific Advice for CO2 Carbon Dioxide	39
8.19.6	Specific Advice for N2 Nitrogen	41
8.19.7	Backup Refrigeration installation	43
8.19.8	Specific Advice for LN2 Liquid Nitrogen	44
8.19.9	Refill LN2 Liquid Nitrogen cylinder	45
8.19.10	Refill LCO2 Liquid CO2	46
Manual Operation		47
9.	Power-On System	47
10.	Doors	48
10.1	Front Door	48
10.2	The Robot Gate	49
11.	Buffer Cassettes	50
12.	Barcode Reader	53
12.1	1D Reader for racks and plates	53
12.2	2D Rack Scanner / Reader	53
13.	Climate Settings	54
13.1	Temperature Settings	54
13.2	Humidity Settings	54
14.	Alert System	54
14.1	STT Alerts	54
15.	Routine Safety Checks	55
Software		56
16.	Sample Management Software	56
16.1	Order File	56
16.1.1	Simple order file	56
16.1.2	Complex order file	57
16.2	Web-Interface	58
16.2.1	Remote Web Access	59
16.2.2	Local Web Access	60
16.3	PlateExplorer	62
16.3.1	General Functionalities	63
16.3.2	Layout of the PlateExplorer	65
16.3.3	Setting up the Plate Explorer	69
16.3.4	Right-Click Action Menus in the Tree View	72
16.3.5	Right-Click Action Menus in the Detail Information Screen	76
16.3.6	Right-Click Action Menus on the Boxer/Picker	77
16.4	The Climate Explorer	78
17.	Basic Configuration Files	79

17.1	Driver Configuration File: DriverConfig.Ini	79
17.1.1	Section: [TCP].....	79
17.1.2	Section: [WEB]	80
17.1.3	Section: [XML]	80
17.1.4	Section [paths].....	80
17.1.5	Section: [database]	82
17.1.6	Section: [Options].....	83
17.1.7	Section: [Messages].....	84
17.2	System Configuration File: System.Ini.....	85
17.2.1	Section: [System]	85
17.2.2	Section: [Unit]	85
18.	Unit Configuration File Types.....	86
18.1	Common Sections	86
18.1.1	Section: [Unit]	86
18.1.2	Section: [ParameterFile].....	86
18.2	STC Store configuration File: Store.Ini	87
18.2.1	Section: [Climate].....	87
18.2.2	Section: [Options].....	87
18.2.3	Section: [Option Configuration].....	88
18.2.4	Section: [Option Configuration2].....	88
18.2.5	Section: [Sensor Configuration].....	89
18.2.6	Section: [Carousel Configuration].....	89
18.2.7	Section: [Climate Configuration]	90
18.2.8	Section: [Partitions].....	91
18.2.9	Section: [CassettesConfiguration]	91
18.2.10	Section: [X-Tilt] – some old systems – liconic tech.....	91
18.3	Interface Configuration File: Interface.Ini.....	91
18.3.1	Section: [Options].....	92
18.3.2	Section: [Option Configuration].....	93
18.3.3	Section: [Option Configuration2].....	93
18.3.4	Section: [Sensor Configuration]	94
18.3.5	Section: [Carousel Configuration].....	94
18.3.6	Section: [Climate Configuration]	95
18.3.7	Section:[Partitions].....	96
18.3.8	Section: [CassettesConfiguration]	96
18.4	TubeBoxer/Picker Configuration File: Boxer.Ini.....	97
18.4.1	Section: [Options].....	97
18.4.2	Section: [Option Configuration2].....	97
18.4.3	Section: [TubesConfiguration]	98
	Trouble Shooting.....	99
19.	Troubleshooting	99
19.1	Basic Errors	99
19.2	Error Listing	100
19.2.1	STT1k5.....	100
19.2.2	TubePicker.....	101
19.3	Handling Errors.....	102
19.3.1	General	103
19.3.2	Free Shovel Procedure.....	104
19.3.3	Init Error Analysis	105
	Safety Sheets.....	106

Introduction

1. About the Product and its Manual

1.1 Intended Use

The LiCONiC Kiwi Store STT 1k5 ULT is intended for storage, identification and transfer of Microplates and Tubes. It is to be applied exclusively in the research field. The LiCONiC Kiwi Store STT 1k5 ULT is intended to work as a stand alone unit or an element in an automated system.

1.2 Unintended Use

Due to its open architecture, the LiCONiC Kiwi Store is NOT intended for regulated clinical and diagnostic applications (IVD Directive).

Read the safety instructions in this Manual carefully.

1.3 Product Identification

The Type Plate is located at the rear of the LiCONiC STT 1 k5 ULT

LiCONiC	
9493 Mauren, Liechtenstein	
StoreX	STX220
Type	HRBT
Catalog No.	9123 05 12
Serial No.	3374
Temp-Range	04 - 50° C
Voltage	100 - 230 V
Hz	50 - 60 Hz
Phase	1
Watts	0.8 KW
Current	4 A
Manufactured	2006.04
	

For future reference, please read the instrument Serial No. on the rear of your instrument and write it in the provided space.

1.4 Scope of Delivery

- Basic Unit, consisting of an Interface Unit with a door, a Plate Handling, a Gate, the Tube Handling and the –80°C storage chamber
- Cooling unit for Interface Unit and storage chamber
- Product Documents
- Cables
- User Software and Drivers
- Stackers (as specified)
- Transfer Station (as specified)
- CO2 backup cooling (only if ordered)
- LN2 Backup (only if ordered, does not include DEWAR)

1.5 General

The LiCONiC Kiwi Store STT 1k5 ULT is a complete product for end users. But it can also be delivered to professional System Integrators who take responsibility for safe installation and documentation of the entire system.

In case of Integration, do not operate until it has been established that the system, into which the LiCONiC KIWI STORE STT 1k5 ULT has been incorporated is in compliance with all local safety regulations.

1.6 Definitions

Operator: Any person who uses the equipment for its intended purpose.

System Integrator: Authorized person or company responsible for integration, installation, initial start up and overall safety of the system.

Authorized Engineer: Authorized person responsible for installation, initial start up.

Person who carries out service and maintenance tasks and is therefore contacted in the case of any problems with the system.

1.7 Target User Group

The Kiwi Store has been conceived for applications in the research field.

Instrument operation requires a trained user.

1.8 Importance of the Safety Instructions

This chapter contains general information assuring safe operation of the instrument. More specific instructions in regard to safety are given throughout this manual, at the respective points where observation is most important.

Make sure that all Safety Instructions in this publication are strictly followed.

1.9 Labels

Throughout this publication, Warning Notices are to be interpreted as follows:



WARNING !

Indicates the possibility of severe personal injury, loss of life or equipment damage if instructions are not followed.



CAUTION !

Indicates the possibility of severe equipment damage if instructions are not followed.



NOTE !

Gives helpful information about the equipment.



DANGER !

May be harmful to your eyes.

1.10 Safety - Basics

1.10.1 General Operating Hazards

Carefully observe the following precautions:

1.10.2 Mechanical Hazards

Keep the housing and safety panels closed and never reach into the instrument work space when the unit is in operating mode.

1.10.3 Electrical Hazards

Keep the housing and safety panels closed. Before opening any of the panels disconnect the power supply to avoid electrical shock.

1.10.4 Chemical, Biological and Radioactive Hazards

All samples and test-kit components must be considered as potentially hazardous agents. Therefore, a potential risk may arise from the liquids being handled, such as infectious biological samples, toxic or corrosive chemicals, or radioactive substances. Strictly apply appropriate safety precautions according to local, state and federal regulations.

Prior to any first time application, test runs should be made with a neutral liquid to allow optimization of all liquid handling parameters.

Handling and disposing of waste has to be in accordance with all local, state and federal environmental, health and safety laws and regulations.

Prior to executing any maintenance task on the instrument or sending it, or parts of it for repair, the instrument or the parts have to be thoroughly decontaminated.

1.10.5 Extreme Temperature Hazards

All surfaces inside the storage chambers, interface and some parts of the refrigeration may be considered as potentially dangerous if touched without sufficient protective clothing. All components externally to the chamber are protected and are not able to be touched. Only if protective covers are removed components with extreme cold or heat may be touchable.

Inside the chamber temperatures below zero degree Celsius are present. Contact to any surfaces with bear skin should be avoided. Protective clothing has to be worn when manual operations are performed inside the chamber.

1.10.6 Suffocation Hazard

When entering the service area of the Storage chamber a potential risk of suffocation is present. A maximum of 15 minutes is given to stay in the service area without a respirator. When entered the service area a O₂ monitor has to be worn under any circumstances. The monitor has to provide at least an adjustable O₂ low limit and an acoustic alert when O₂ level is too low.

It is not allowed to work inside the system alone. A second person has to be outside surveying the work inside and to be in permanent contact with a radio with the person inside.

1.11 General Safety Regulations

1.11.1 Legal Requirements

Please consult the Manufacturer's Declaration, delivered with each unit by LiCONiC AG, listing all applied directives and standards.

In Europe, the System Integrator must provide a Conformity Declaration upon final installation of the entire system.

1.11.2 General Inspection and Maintenance Duties

Only an authorized Engineer shall carry out inspection, maintenance and repair tasks.

1.11.3 Spare Parts to be used

Only original LiCONiC Spare Parts may be used. If other parts are used during the normal warranty period, the manufacturer's guarantee may be invalidated.

1.11.4 Modifications

Modifications shall only be carried out by an authorized Engineer. LiCONiC AG will not accept responsibility for any claim resulting from unauthorized modification or alteration.

General

2. The Kiwi Store Family

2.1 Kiwi Store

The Kiwi Store Series is the most compact Storage with Integrated Handling that covers tube and plate storage needs at -20°C and -80°C . The Kiwi Store Series offers dry climate storage.

The modular mechanical design in combination with extremely simple commands eases the integration of a Kiwi Store into any environment. A growing number of accessories are available for the Kiwi Store Series.

2.2 Kiwi Store STT 1k5 ULT Features

All Kiwi Store units have compact dimensions. The Kiwi Store has a user front door which allows comfortable and easy access for manual operation. The glass window allows visual inspection of the content and operation of the system without disturbing the internal climate. Removable stackers make the use of the Kiwi Store even simpler and more efficient. Stackers are available for all common plate types.

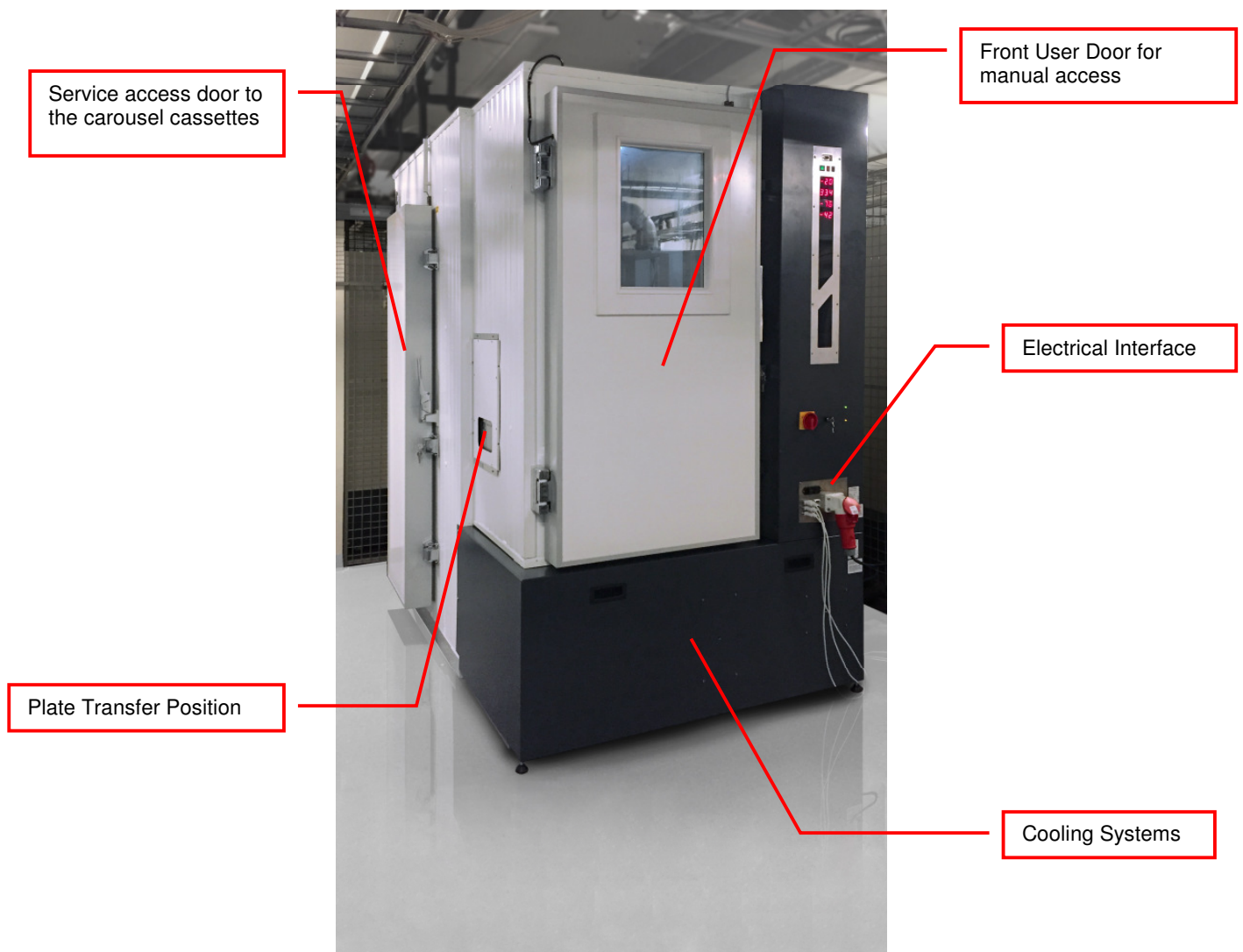

2.3 Kiwi Store STT 1k5 ULT Capacity Examples

The Family of Kiwi Store is structured by their capacity in Microtiter plates (MTP) and their climate.

The Kiwi Stores are Stand Alone units with the possibility to be integrated into a robotic Platform. The height of transfer position of the units is ~1000mm above ground.

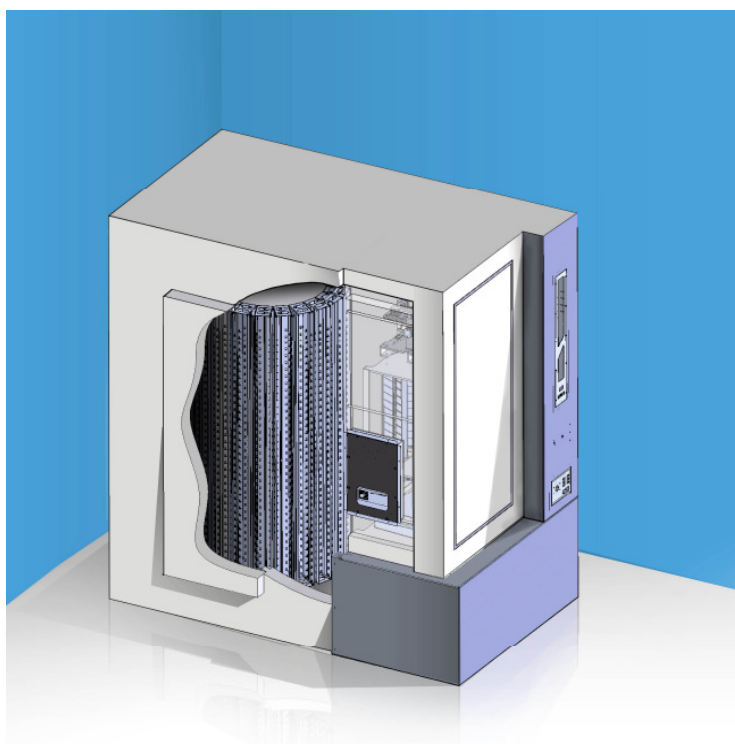

Below capacity of specific labware is given in MTP and Tubes :

Labware	MTP / Racks	Tubes
REMP 96 - 300	1140	109440
Abgene 0.3 ml / Matrix 0.5 ml	1060	101760
Abgene 0.65 ml	800	76800
Abgene Twist - Lock 0.5 ml	760	72960
Matrix 0.75 ml	720	69120
Matrix 0.5 ml Screw Top	680	65280
REMP 96 - 900	640	61440
Matrix 1.4 ml	580	55680
Abgene 1.2 ml	560	53760
Matrix 1.0 ml Screw Top	520	49920

These capacities are an excerpt of the most commonly requested sizes. Further Storage sizes are available on request. All Kiwi Store can handle and store all types of plates and racks with SBS standard format. The corresponding capacity is only depending on the height of the racks.

Dimensions of STT1k5 ULT Kiwi Store :

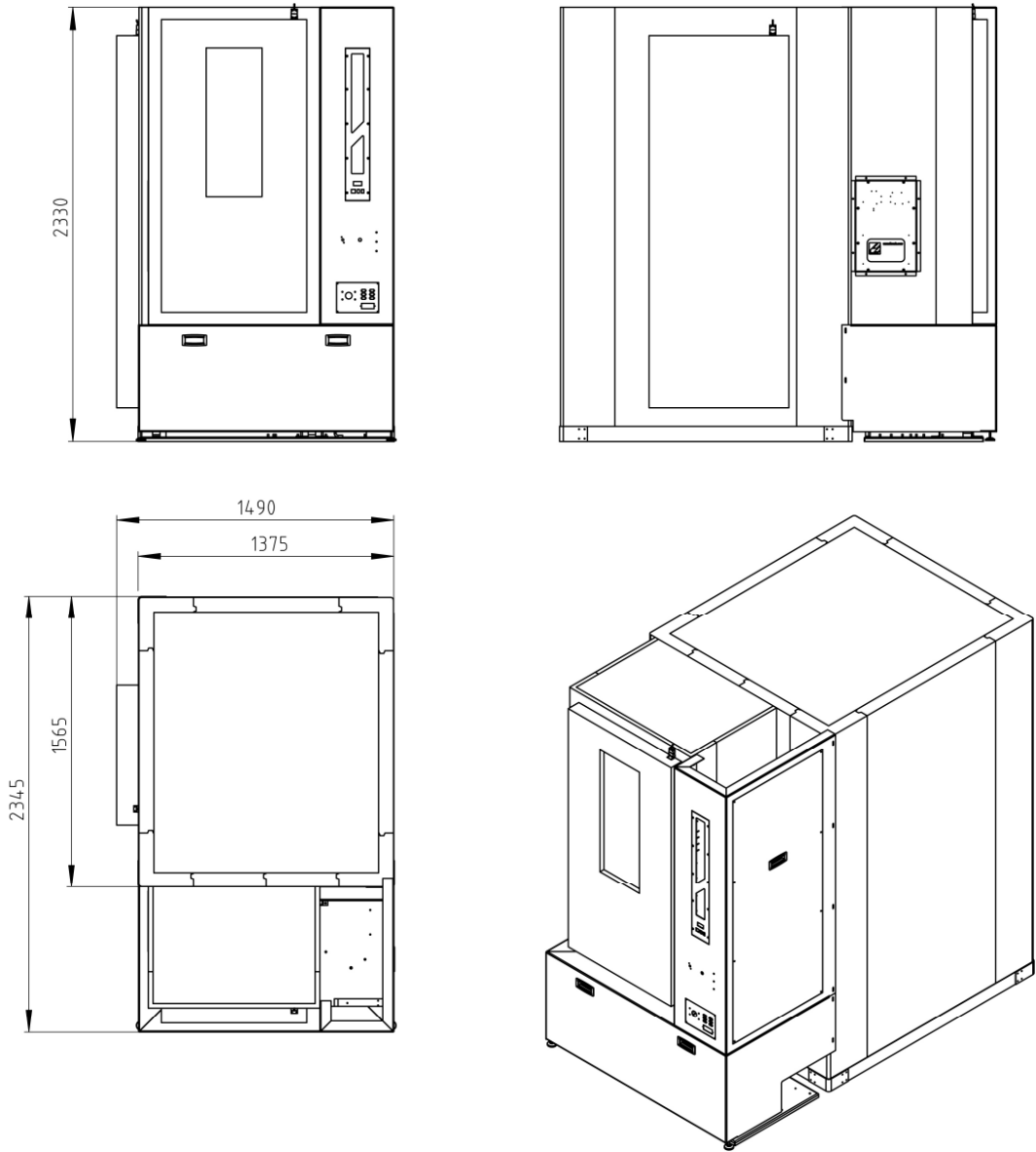

Options

3. Climate of LiCONiC Kiwi Stores

3.1 Overview

Name	Temperature	Humidity
DF Deep Freezer	-20..00°C	02..45%RH
ULT Ultra low temperature	-80°C	n.a.

The KiWi DF Stores are designated for the use as compound storage, whereas the ULT version is mainly for Biobanking use.

3.2 Cooling

Within all units the air is actively dried by forcing the air through an evaporator. This allows cooling and actively drying the air. Since the evaporator gets covered with ice after a certain time these units have an automatic defrost function. The collected water will be exhausted through a drain.

3.3 Temperature

All units are equipped with an Temperature-Sensor. This allows displaying the temperature inside the storage chamber. A very high quality sensor is used for this purpose. Quality and accuracy of the sensor is maintained by the Swiss Federal Office of Metrology and the Swiss Accreditation Service (see specification in next chapter).

Due to the limited temperature range this sensor is used in the ULT storage systems to monitor and control the climate in the service area. To monitor all other temperature, such as parameters of cooling and storage chamber temperature, thermocouple are used.

3.4 Humidity

All units are equipped with an RH-Sensor. This allows displaying the humidity inside the storage chamber. A very high quality sensor is used for this purpose. Quality and accuracy of the sensor is maintained by the Swiss Federal Office of Metrology and the Swiss Accreditation Service.

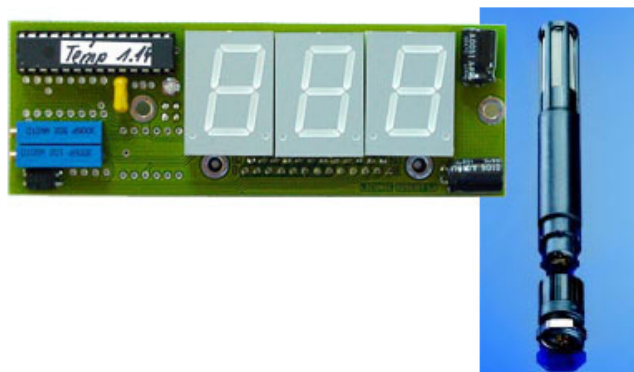

The Humidity sensors used in the Kiwi Store series are suitable for extremely high humidity as well as for extreme dryness. They incorporate a humidity and a temperature sensor allowing a relative humidity (RH) readout.

Specifications

Measuring Range	0..100	% RH
Accuracy@23°C	±1.5 ±1.3	% RH °K Temp.
Resolution	12 12	Bit / 0.02% Bit / 0.1°C
Sensor	PT100 C94	Temperature Humidity
Adjustment	-	E2-PROM

4. Backup solutions for Kiwi Stores

4.1 Overview

Name	Temperature	Principle
CO2 Backup	-75°C	Evaporator for CO2
LN2 Backup	-80°C	Evaporator for LN2

The Kiwi Store gas backup solutions are optionally installed to cover power outages or a failure of the main cooling unit.

4.2 CO2 Backup cooling for temperatures above – 75°C

The CO2 Backup solution is for the use in DF systems to maintain the temperature during power failure. The CO2 bottle is connected to a controlled inlet to the chamber injecting CO2 to maintain cold.

This option includes the tubing and the control. This backup solution is fully monitored to ensure the temperature to stay at –20°C. Also an exhaust is part of this option.

If the CO2 backup cooling is coming into action large amounts of CO2 are released through the options exhaust. Therefore the exhaust needs to be lead out of the building to not endanger personnel working in the area of the system.



WARNING !

- Inert gases are asphyxiates and will displace oxygen to produce localized oxygen deficient atmospheres
- Inert gases are odorless, colorless and tasteless
- Inert gases give no warning and may cause death in few seconds
- The Exhaust of the CO2 backup cooling option needs to be lead out of the building otherwise danger of suffocation is immanent
- In their liquid state inert gases are extremely cold fluids which can cause serious burns when in contact with the skin

- A cryogenic spill often gives a low lying cloud of vapor that creeps along the ground

4.3 LN2 Backup cooling

The LN2 Backup solution is for the use in ULT systems to maintain the temperature during power failure. The LN2 Dewar is connected to an additional evaporator specially designed for cooling use with LN2.

This option includes the evaporator, the tubing and the control, the Dewar is not included. The size of the Dewar is defined by the desired backup time and the desired refill interval. This backup solution is fully monitored to ensure the temperature is maintained. Also an exhaust is part of this option.

If the LN2 backup cooling is coming into action large amounts of N2-Gas are released through the options exhaust. Therefore the exhaust needs to be lead out of the building to not endanger personnel working in the area of the system.



WARNING !

- Inert gases are asphyxiates and will displace oxygen to produce localized oxygen deficient atmospheres
- Inert gases are odorless, colorless and tasteless
- Inert gases give no warning and may cause death in few seconds
- The Exhaust of the LN2 backup cooling option needs to be lead out of the building otherwise danger of suffocation is immanent
- In their liquid state inert gases are extremely cold fluids which can cause serious burns when in contact with the skin
- A cryogenic spill often gives a low lying cloud of vapor that creeps along the ground

5. Identification

5.1 Barcode reader

A Bar Code Reader is installed on the Lift Assembly. It allows the reading of Bar Codes on plates stored in the stackers. Bar Codes have to be printed on the shorter side of the plates and have to face outwards to the KIWI STORE Lift Assembly.



5.1.1 Supported Barcode Types

The optional Barcode reader recognizes the following barcode types.

- | | | |
|---------------------|-------------|-------------------------------|
| • CODE128 | max. digits | : 74; 148 (Start character C) |
| • CODE39 | max. digits | : 74 |
| • NW-7/Codabar | max. digits | : 74 |
| • UPC/EAN | max. digits | : 74 |
| • GS1-128 (EAN-128) | max. digits | : 74 |
| • GS1 DataBar (RSS) | max. digits | : 74 |
| • ITF | max. digits | : 74 |
| • Industrial 2of5 | max. digits | : 74 |
| • Standard 2of5 | max. digits | : 74 |
| • COOP 2of5 | max. digits | : 74 |
| • CODE93 | max. digits | : 74 |

5.1.2 Barcode Specifications

- | | |
|---------------------------|---|
| • Light Source: | Semiconductor Laser |
| • Wavelength: | 660nm |
| • Output: | 1.0mW |
| • Class: | Class II (JIS C6802)
IEC /EN 60825-1 A2:2001 |
| • Reading Bar Width: | min. 0.1 mm |
| • Ambient Light: | Sunlight 10'000 lx |
| • Incandescent Lamp: | 6'000 lx |
| • UL Applicable standards | UL508, UL60950-1 |
| • UL File No. | E207185, E167973 |
| • UL category | NRAQ/NRAQ7, NWGQ2/NWGQ8 |

5.2 2D Code rack scanner

A 2D code rack scanner can be integrated into the Liconic software. It allows the reading of 2D Codes of a whole rack at once. To read the 2D code the rack needs to be placed manually on to the reader at the outside of the system.

5.2.1 Supported 2D code Types

The optional 2D code reader recognizes the following 2D code types.

- DataMatrix

5.2.2 2D code scanner Specifications

- Scanning Device: Customized flatbed scanner
- Compatible rack vendors
 - Thermo Matrix
 - Thermo Abgene
 - Thermo Nunc
 - Remp
 - Micronic
 - FluidX
 - And all other 2D coded tubes
- Compatible rack sizes: 96, 48, 24
- Export data to Excel, text, XML, rack images
- Database connectivity: SQL Server, Oracle, MySQL, Postgres, HSQL and others [v1.23+]
- Fast Scanning — 5 seconds per rack
- Displays damaged/missing tubes
- One-click scan for any size or brand of tube
- Simple installer — no dongles required
- Multiple scanners/multiple configurations
- 110/220 v automatically selected
- Fully integratable into robotics platforms

Accessories

6. Transfer Stations

LiCONiC offers a wide range of different transfer stations. Due to special design of some of the storage units not all transfer stations are available for each unit. Below find details of the Standard Transfer Station for the STT 1k5 ULT system.

6.1 Standard Transfer Station for STT1k5 ULT

The transfer station is accessed by the KIWI STORE handler as well as any external robot. The transfer station allows most grippers access to the plate. The transfer station is equipped with alignment pins to realign the plates in both horizontal directions. The alignment works for the handling as well as for any external robotic transportation system. The plate presence on the transfer station can be checked with an optical sensor mounted at the side of the transfer nest.

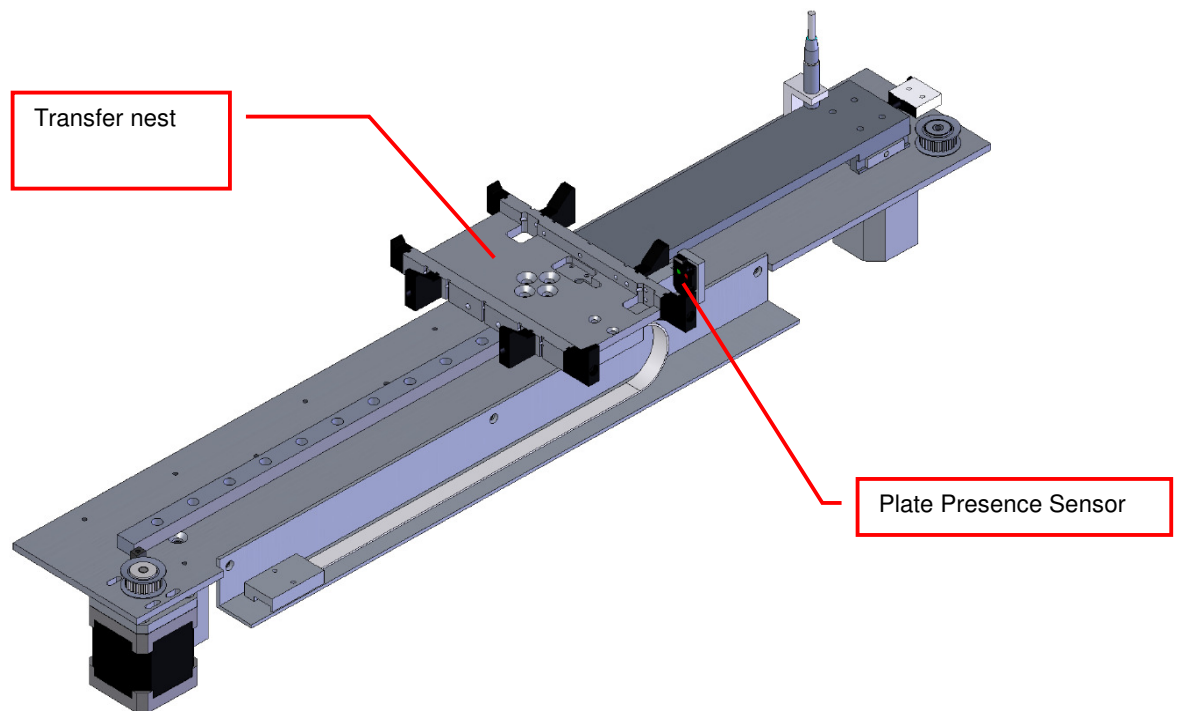

6.2 Standard Transfer nest

Transfer Plates have alignment features (black) which realign the plates in both horizontal directions if placement was not executed exactly in the nest centre. Transfer nests are manufactured in aluminum with an anodized surface finish.

6.3 Transfer nest Sensor

A sensitive optical sensor is integrated into the Transfer Stations. The Transfer nest Sensor will detect all commonly used plates. Transparent, opaque, white or black plates are detected. The miniaturized design of the sensor; mounted at the side of the transfer nest; helps to keep the Transfer Station compact. The Transfer Plate Sensor is connected to the systems controller and software. The current sensor status can be requested through the handling communication port.

7. Kiwi Store Cassettes for STT 1k5 ULT

The interface unit includes two buffer cassettes which are 305 mm in height if a 2D rack reader is installed or 505 mm in height if no 2D rack reader is installed.

The store carousel is designed for 20 cassettes total, each cassette 1600 mm in height. The capacity in tubes depends on the specific height of labware / racks.

Below capacity of specific labware is given in MTP and Tubes :

Labware	MTP / Racks	Tubes
REMP 96 - 300	1140	109440
Abgene 0.3 ml / Matrix 0.5 ml	1060	101760
Abgene 0.65 ml	800	76800
Abgene Twist - Lock 0.5 ml	760	72960
Matrix 0.75 ml	720	69120
Matrix 0.5 ml Screw Top	680	65280
REMP 96 - 900	640	61440
Matrix 1.4 ml	580	55680
Abgene 1.2 ml	560	53760
Matrix 1.0 ml Screw Top	520	49920

The Kiwi Store can handle almost every plate or tube racks in SBS formate currently available on the market. For optimum performance LiCONiC offers a variety of cassettes.

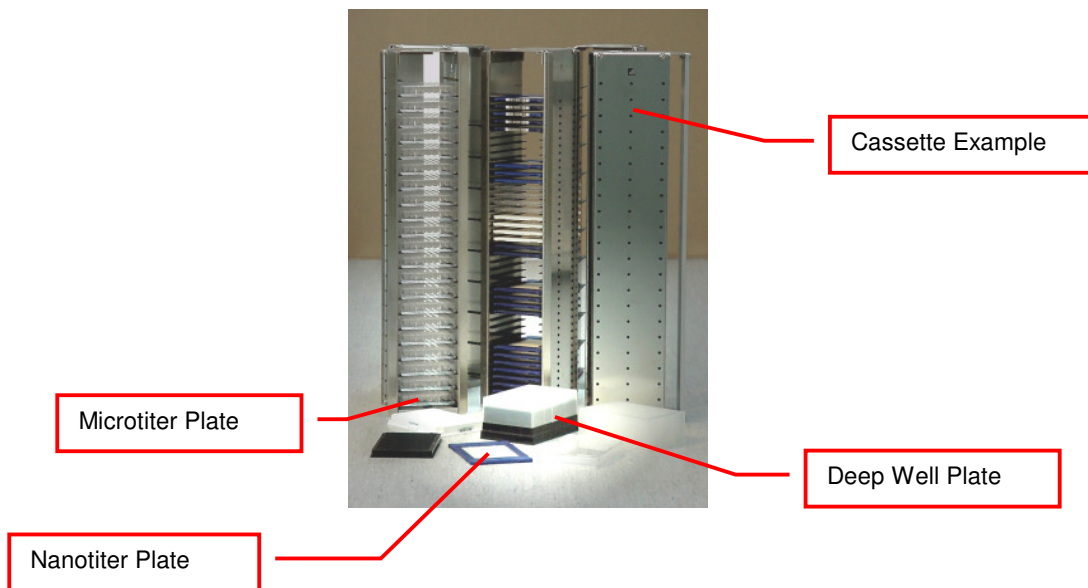

Installation

8. KiWi Store STT installation

8.1 3D-View

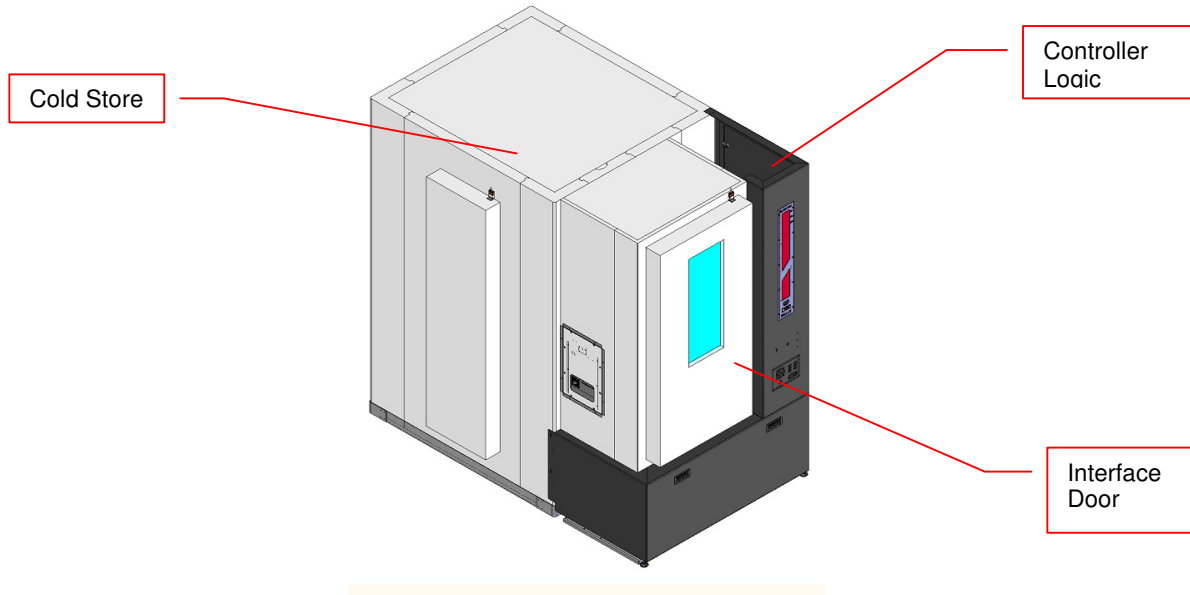

8.2 Top view

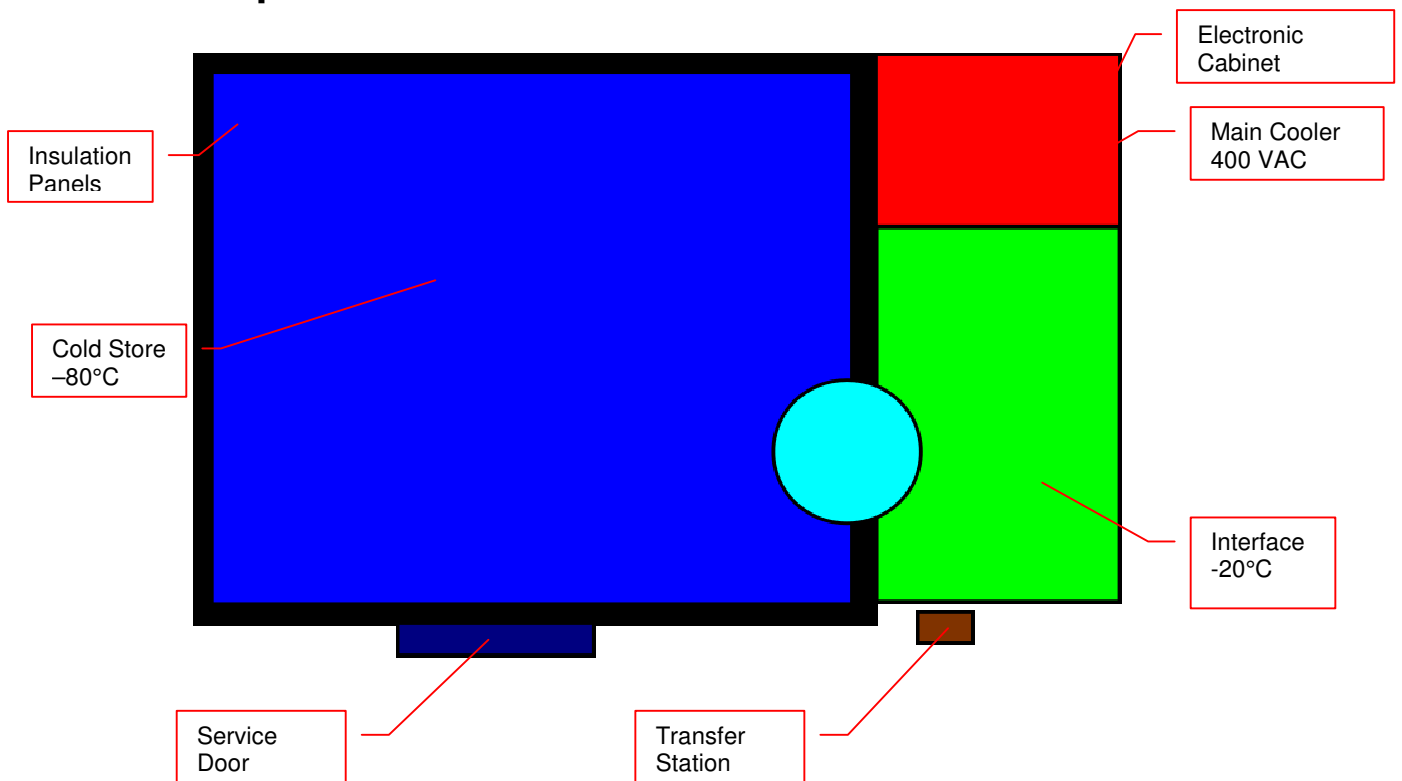

8.3 Panel Locations

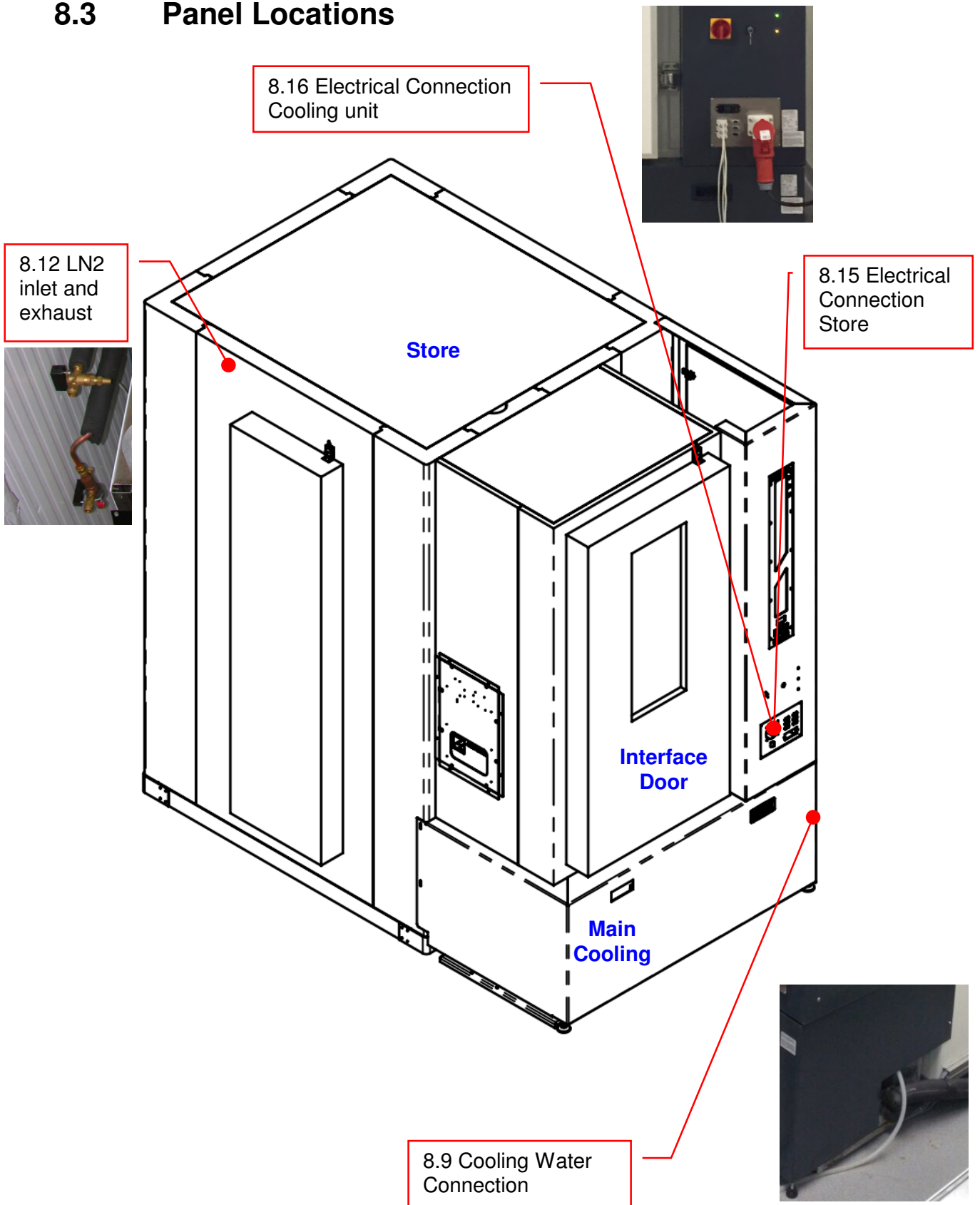

8.4 General Requirements

Requirement	Details
Ambient	Temperature: max. 22 °C Humidity: < 40%
Room height	2.5 m
Ground cooling	10W/m ² (Cooling energy loss passed on to the ground)
Floor load	Recommended 500 kg/m ² (for smaller load specifications please consult clearance recommendations with Liconic Applications team, case-by-case approval required)
Point load	250 kg
Heat dissipation	< 2kW
Flatness	+/- 1mm per 1m
Accessibility	Room has to be accessible from 7am - 7pm for installation
Storage	A room has to be supplied to lock in all tools and material
Communication	RJ45 Connector Access to Network

8.5 Clearance Requirements

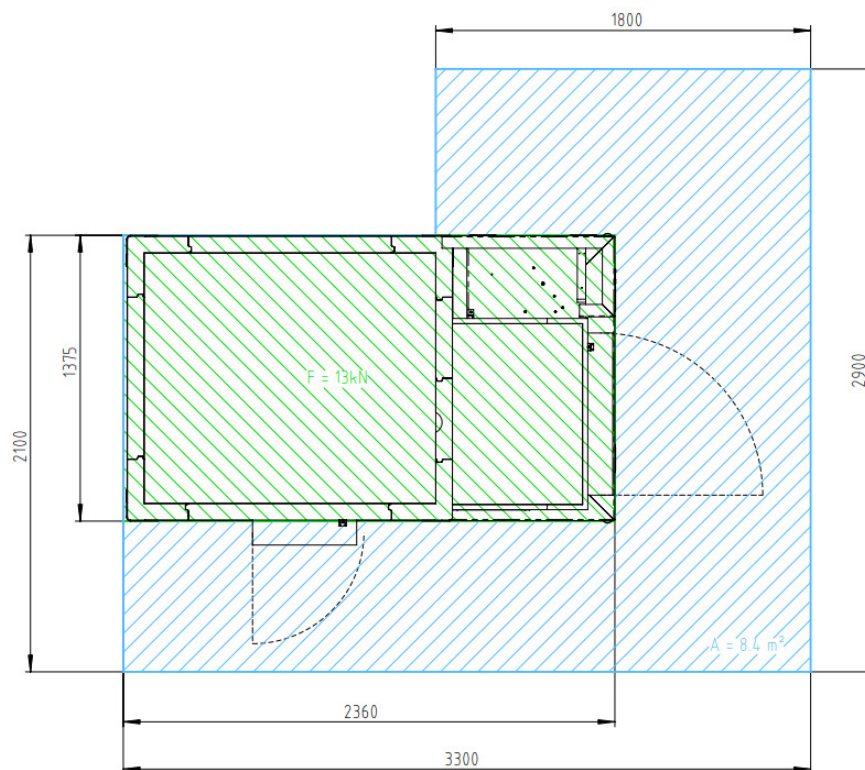

8.6 Refrigeration Elements Overview

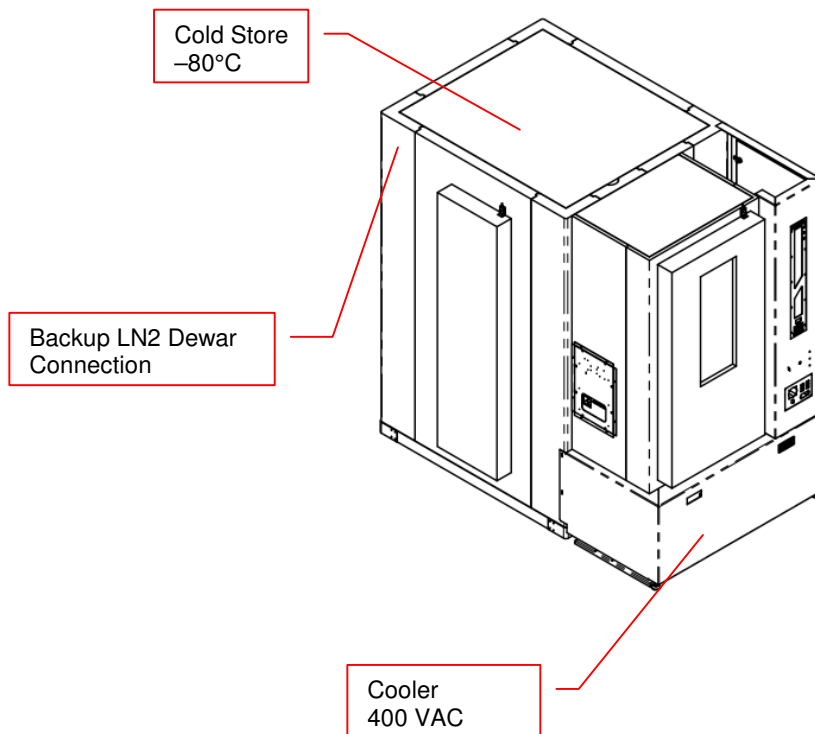

8.7 Electrical Refrigeration Principles

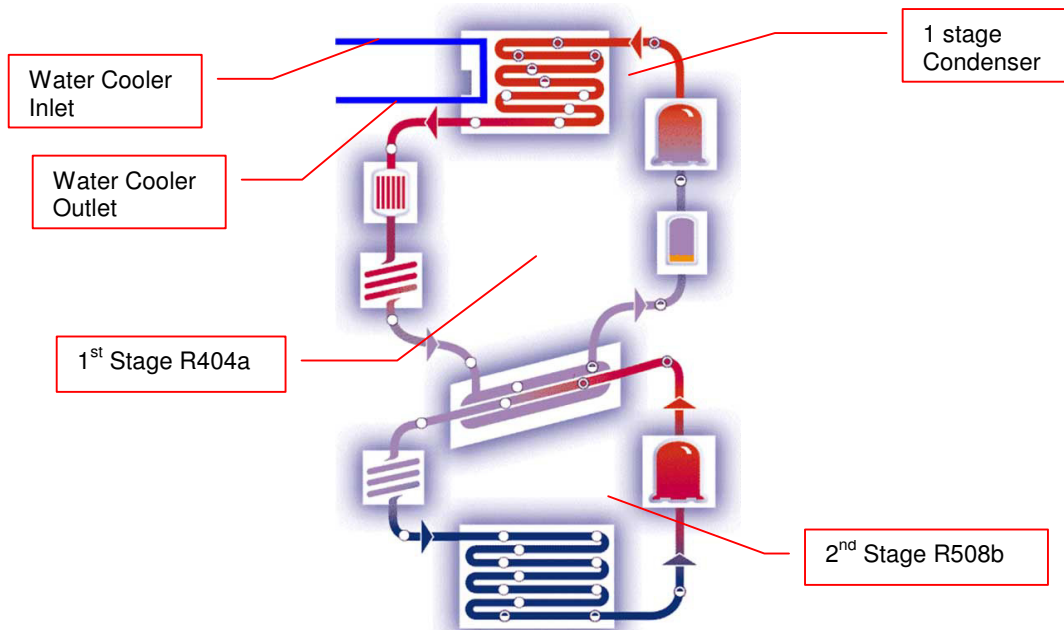

8.8 Cold Water Cooler

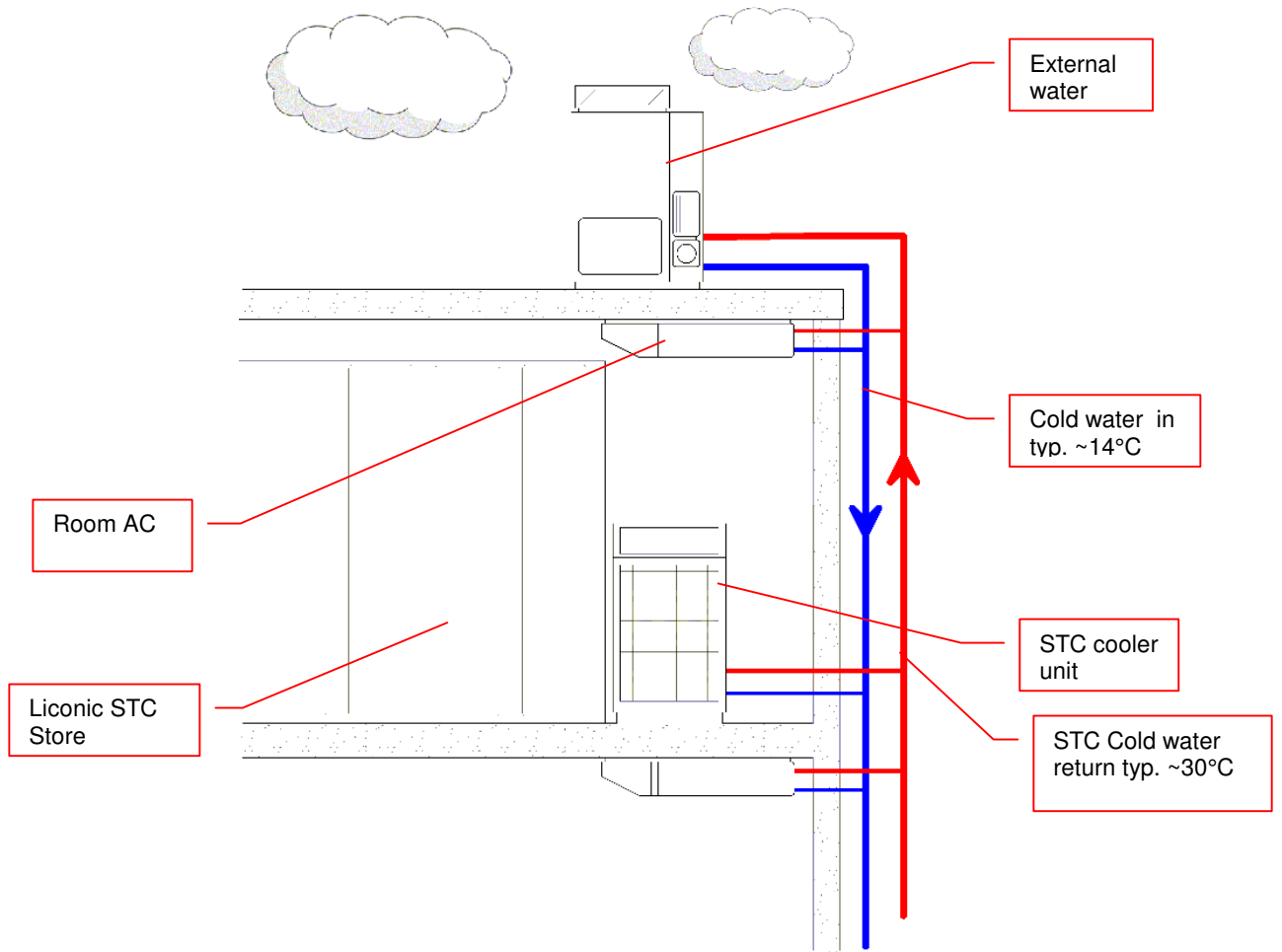

8.9 Typical Water Cooler Integration

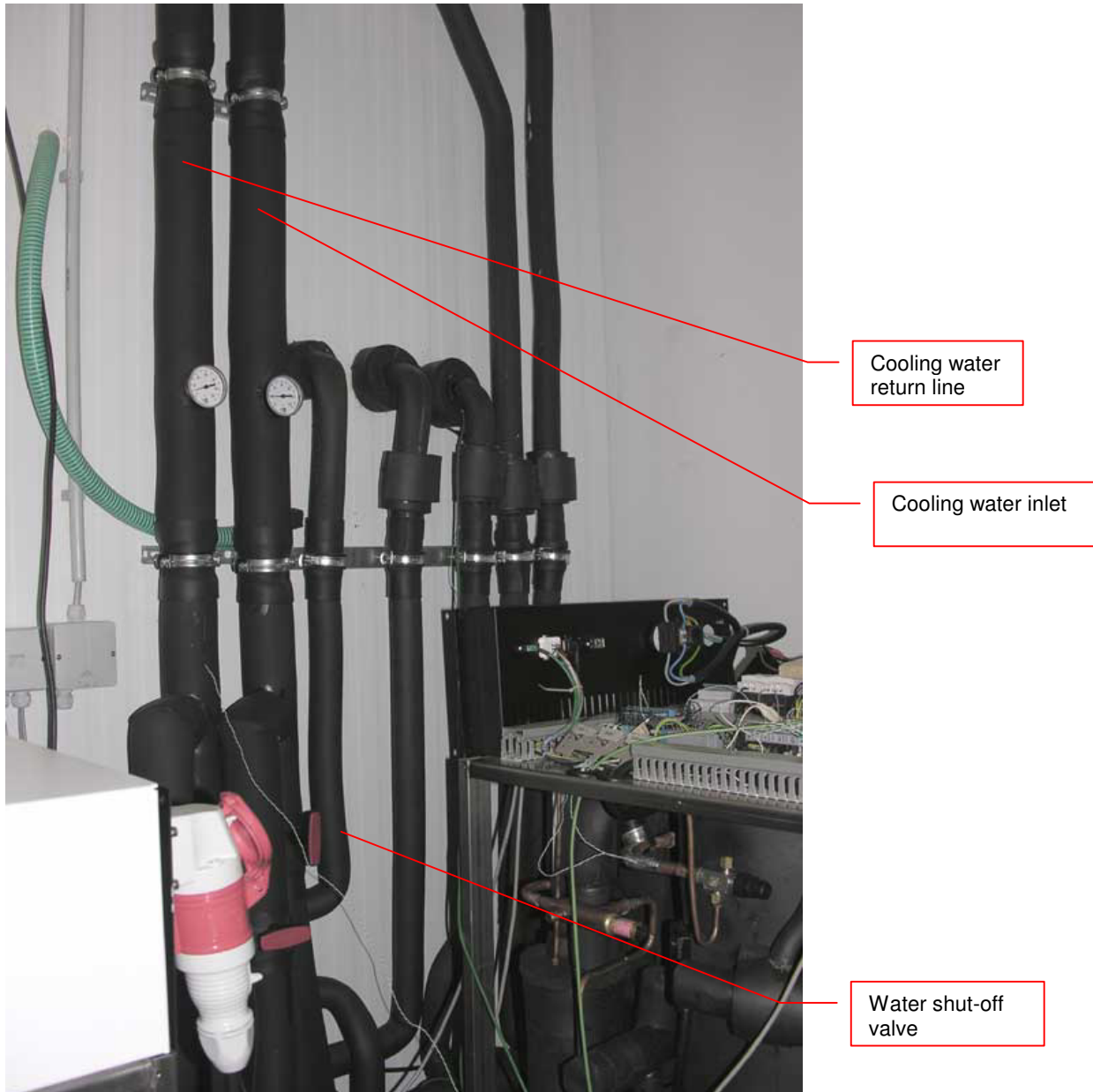

8.10 STT Cooling Water Connection

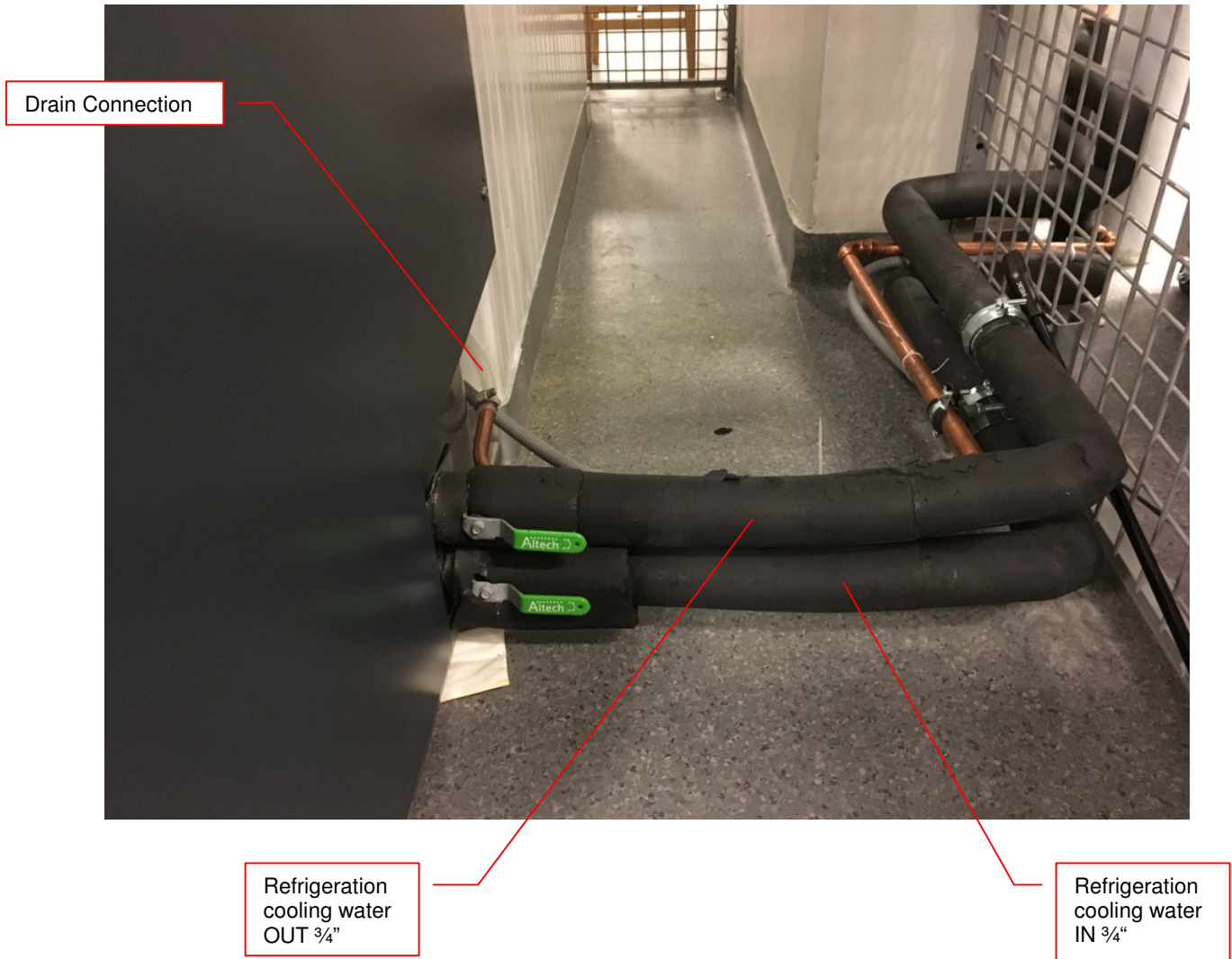

8.11 Requirements Cooling Water

Requirement	Details
Cooling	<p>Media: Water Water quality: Tap water quality, clear Suspended solids: None Conductivity: 50-600 uS/cm Hardness: < 8° dH PH: 7.8 CO2 aggressive: None Iron: < 0.3 mg/L Manganese: < 0.05 mg/L Sulfate: < 250 mg/L Chloride: < 250 mg/L COD: < 40 mg/L Bacteria: < 1000 CFU/ml Pressure Difference: 2.5 bar (p.e.: IN 5 bar; OUT 2.5 bar) Max. Inlet Pressure: 10 bar Temperature: IN 5 .. 14 °C Flow: typ. 3-5 l/min @12°C Temperature Return: 35°C Connection fittings: 3/4" male Individual connections for main and redundant cooling Mixture of Water with Glycol are possible.</p>
Typical pump used for cooling loop	
Water Connections	<p>2x 3/4" male Cooling: 1x Inlet; 1x Return</p>
Drain	<p>Interface Module at -20°C may perform regular defrost cycles. Interface Module at -20°C is equipped with a drain tube leading the gathered water out of it. Solution to remove the water may be foreseen. In the most simple case an evaporation pan could be used. (Water would evaporate into the room over time) More sophisticated solution would be to provide a drain to guide the water out of the room.</p>

8.12 LN2 Backup Connections

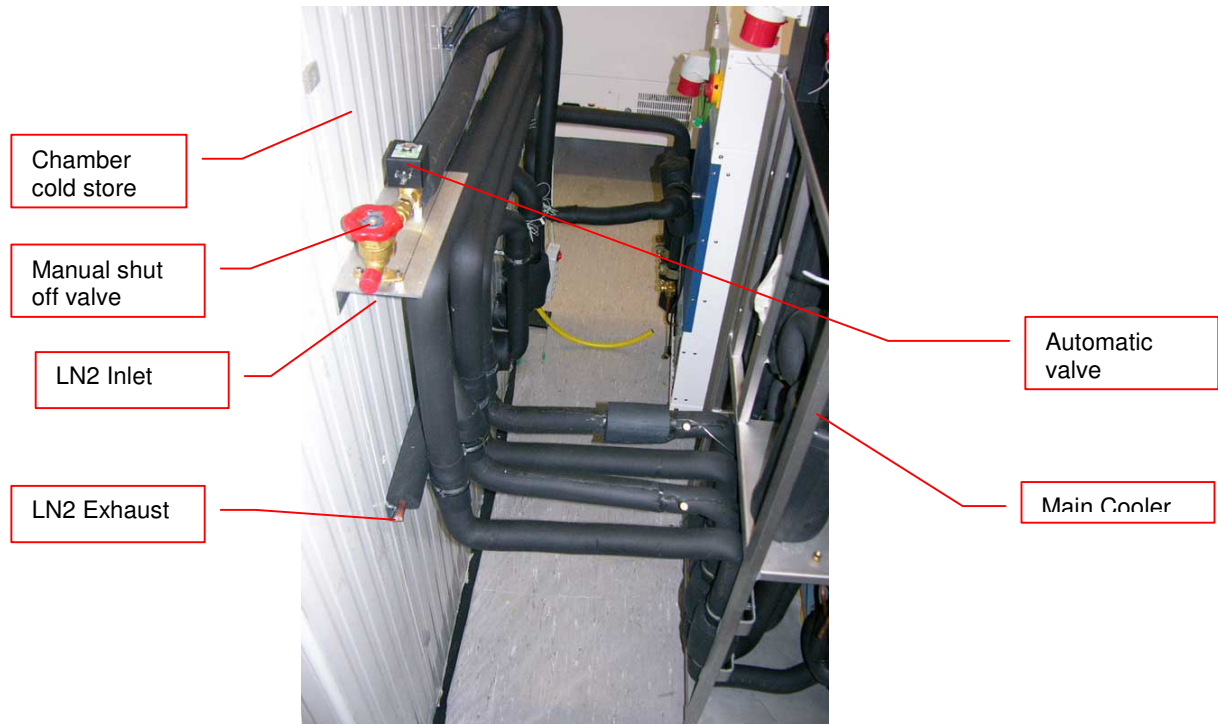

8.13 LN2 Requirements

Requirement	Details
Media	LN2
Refill interval	Depending on DEWAR-Volume With respect to the Leak rate the DEWAR has to be refilled to maintain the minimum desired backup time. Specifications based on Cryotherm Apollo 350: 24 h Back up = Consumption: 209 - 298 L Refill: about every 28 - 80 days (recommended once a month)
Cooling time	Depending on DEWAR-Volume Specifications based on Cryotherm Apollo 350: 100% filled: typically 28 - 40 h 50% filled: typically 14 - 20 h
LN2 Consumption	7-10 kg/h = 8.7 - 12.4 L/h
Leak rate	Depending on DEWAR Specification based on Cryotherm Apollo 350: 0.5% / Day
Supply Pressure	1.5 bar
Supply Connection	1/2" SAE Male, Manual Shut Off Valve and automatic Valve after connection
N2-Exhauste	Exhaust is necessary. In case of use of backup cooling N2 will be released into the environment The Exhaust has to be guided out of the building.
N2-Exhauste Connection	1/2" Open end copper tubing. A unidirectional valve is installed in the line to prevent any air leaking into the LN2 Backup circuit

8.14 Electrical Overview

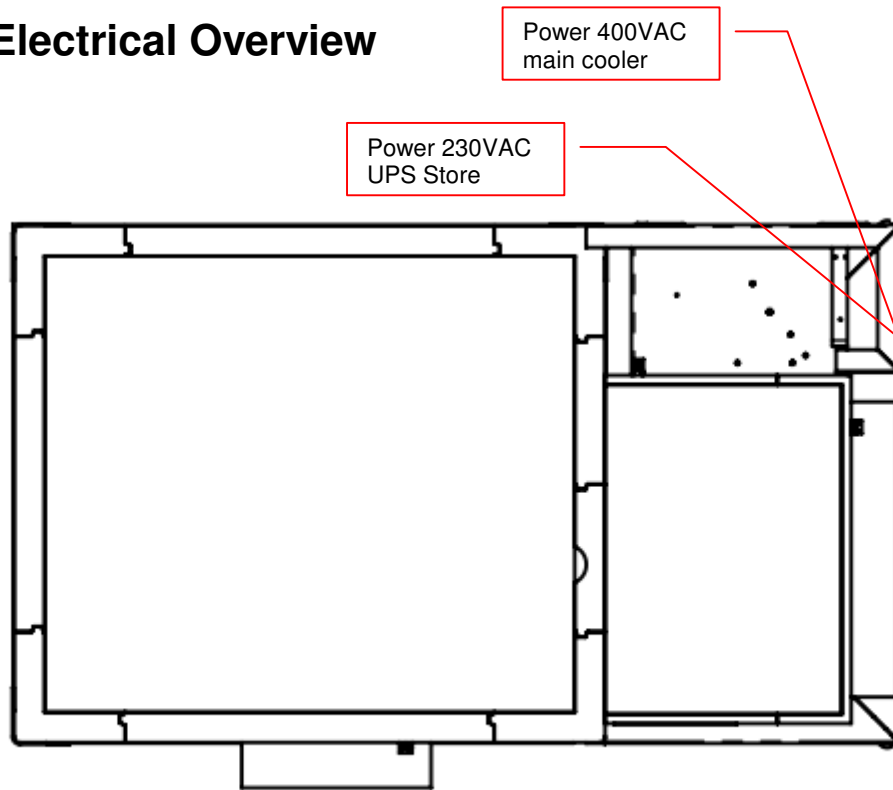

8.15 Electrical Connections System



8.16 Electrical Connections Cooling unit

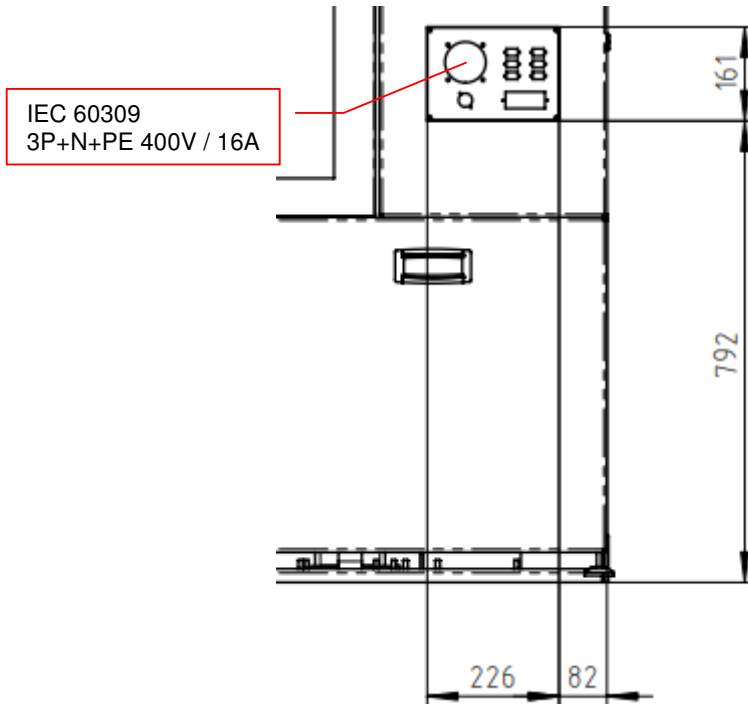
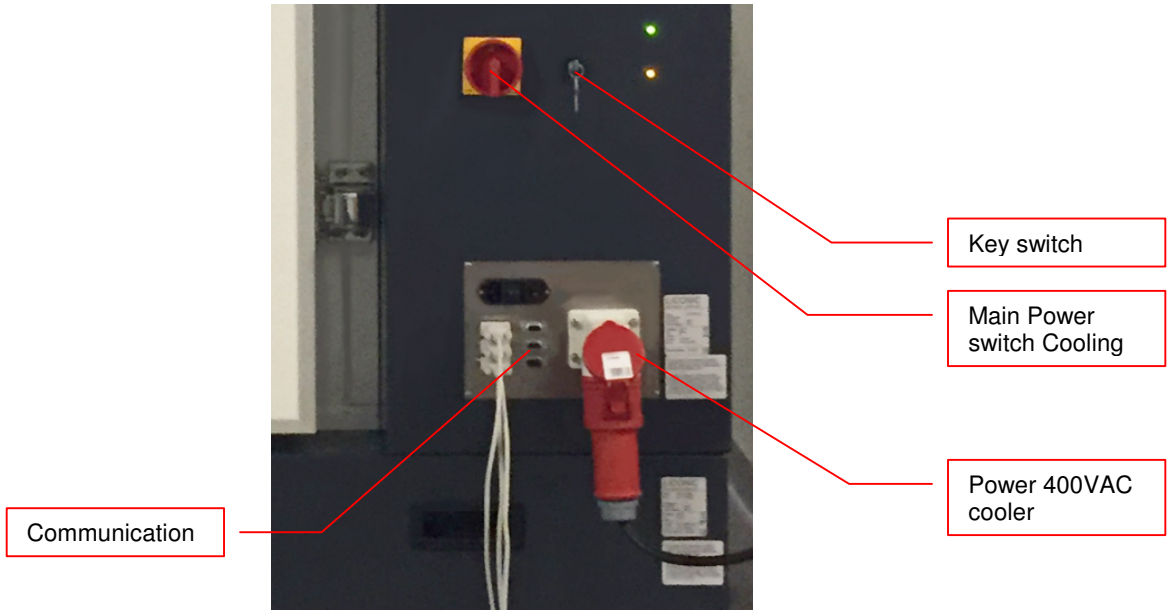

8.17 Electrical Connections Interface

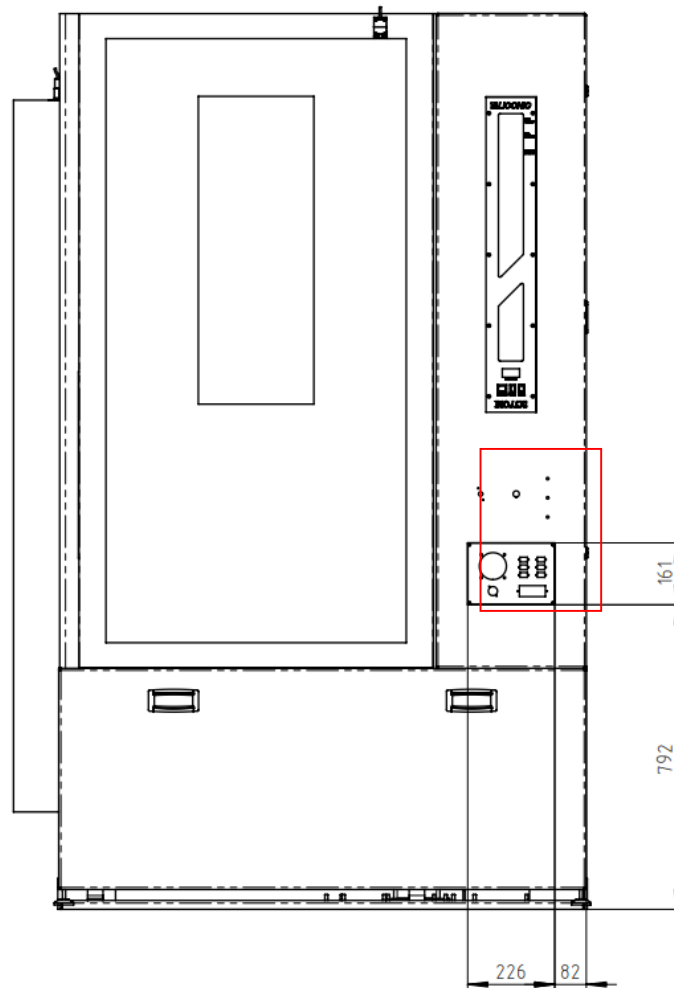
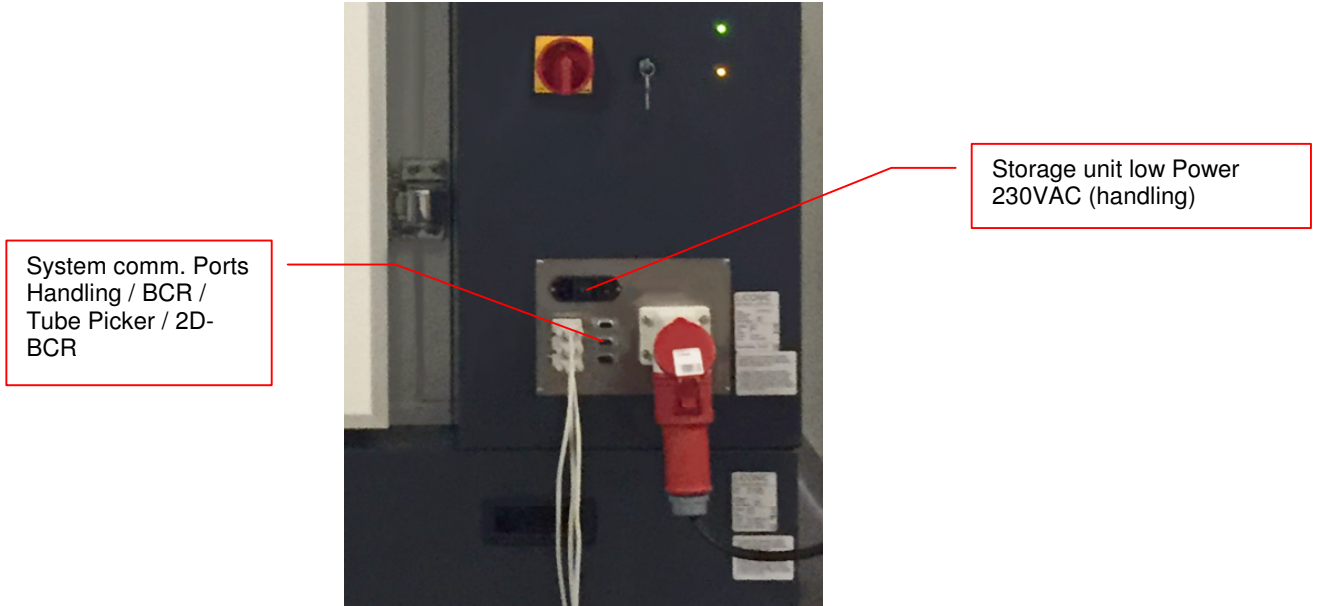

8.18 Electrical Requirements

Requirement	Details
Supply Refrigeration Store	380V / 50Hz 3 Phases Fuse: 16A (Type: C) Connector: CEE Type 611, 16A 5-Pol: 3xL, N, G (IEC 60309) Phase sequence: clock wise
Power consumption Refrigeration	Typically: Current: 8 - 10 A Voltage: 380V / 50Hz 3 Phases Power: 2.5 - 6 kW
Supply Logic Control Unit Store	230V / 50Hz UPS protection Fuse: 10A Connector: Type C14, 10A 3-Pol: L, N, G
Power consumption Logic Control Unit Store	Typically: Voltage: 230V / 50Hz Power: < 1 kW

8.19 Gassing Installation

8.19.1 Kiwi Store Gassing and Backup Options

The Kiwi Store series supports a wide selection of gassing and backup options. Typical properties of some commonly used options are described next. There are other gassing options available. Note that each gassing and backup option is linked to specific risks and hazards. It is important to be fully informed about any specific application before installing the instrument or even running any application.

8.19.2 Safety Information

General

Commonly used in research medicine are inert gases like: Nitrogen, Argon, Helium and Carbon Dioxide. Inert gases are used mainly to create and maintain inert atmospheres for an application or process. The above gases, which generally don't react with other materials, displace oxygen in order to maintain an inert, contaminant free atmosphere.

In their liquid form these gases are very cold, (the boiling point of liquid nitrogen is -196°C). Such cold liquids are known as cryogenic liquids, (from the Greek, kryos meaning frost and gene meaning producing). The liquid gases therefore can be used as backup cooling option in case of power failure.

Major hazards

There are some major hazards associated with these gases



WARNING !

- Inert gases are asphyxiates and will displace oxygen to produce localized oxygen deficient atmospheres
- Inert gases are odorless, colorless and tasteless
- Inert gases give no warning and may cause death in few seconds

Oxygen is the only gas, which supports life. The normal concentration in the air that we breathe is approximately 21%. If the oxygen concentration in air diminishes or, (what amounts to the same) if the concentration of inert gases increases, a situation is rapidly reached where the hazards of asphyxia become very great.

The danger occurs as soon as the oxygen levels are lower than 16%. Inert gases are odorless, colorless and tasteless and are therefore a great deal more dangerous than other gases such as chlorine, ammonia, or hydrogen sulfide, which can be detected by their odor, at very low concentrations. The asphyxiating effect of inert gases occurs without any preceding physiological signals which could alert the victim. It takes place very rapidly: just a few dozen seconds with very low oxygen content. Stated clearly "you do not notice that you are passing out!"

The danger from the inert gases such as nitrogen, argon, helium, etc cannot be stressed enough!! . Especially in this case of Asphyxia as there are no warning signs. People also vary considerably in their reactions to oxygen deficiency.

**WARNING !**

- In their liquid state inert gases are extremely cold fluids which can cause serious burns when in contact with the skin
- A cryogenic spill often gives a low lying cloud of vapor that creeps along the ground

When a cryogenic liquid is released into the atmosphere, it evaporates and forms a dense cloud. As it is very cold it is heavy and hangs close to the ground. So it will flow into any low lying areas, such as drains or pits. Therefore the first warning of a cryogenic spill is often given by the presence of a low lying cloud of vapor that creeps along the ground. These clouds can be dangerous, as their temperature or composition will be unknown. Visibility within the cloud is very low with the possibility of falling, perhaps into contact with the cryogenic liquid. If the cloud is nitrogen or argon then it is very likely that the cloud does not contain sufficient oxygen to support life. In this case unconsciousness could be immediate and death could follow.

**CAUTION !**

- When you see a cryogenic spill or a large vapor cloud notify qualified personnel immediately
- Shut off the source of liquid, by a REMOTELY controlled valve
- Do not enter a vapor cloud caused by vaporizing cryogenic liquid
- DO NOT SMOKE!

When you see a cryogenic spill or a large vapor cloud notify qualified personnel immediately. Call the Fire Department in the case of a large liquid oxygen spill. Have them stand by until the spillage is dispersed.

If possible shut off the source of liquid, by a **remotely** controlled valve if one is fitted. Do not expose yourself to the hazard, such as high oxygen, combustible or asphyxiating atmospheres or cryogenic liquid. Do not allow liquid oxygen to enter drains or sewers. If so advised, shut down any air conditioning or ventilating systems that may draw vapor or gas from the spill into other locations.

If it is essential to enter a cloud caused by nitrogen or argon (note: never enter one that could be rich in oxygen), then wear a self contained breathing apparatus provided you are trained and qualified to do so. A stand-by person, also wearing breathing apparatus must keep you under surveillance. If the release is oxygen, then your clothes could be saturated making them extremely flammable. If you suspect that you have been contaminated with oxygen do not go near any source of ignition for no less than 15 minutes. Ventilate your clothing; change if possible. A fire may occur at any time in the oxygen cloud, should it come into contact with highly combustible material.

General Safety Instructions

When working with inert gases prevent contact of liquid gas, cold vapors, or "snow" with exposed skin. Prevent entrapment of liquid in closed systems. Use only in well ventilated areas. Compressed gas cylinders contain gaseous and liquid gas at extremely high pressure and should be handled with care. Use a pressure-reducing regulator when connecting to lower pressure piping systems. Secure cylinders when in use. Never use direct flame to heat a compressed gas cylinder. Use a check valve to prevent backflow into a storage container. Avoid dragging, rolling, or sliding the cylinders, even for a short distance. Use a suitable hand truck. For additional handling recommendations on compressed gas cylinders, consult the Compressed Gas Association Pamphlet P-1.



CAUTION !

- Wear loose fitting gloves of impermeable material such as leather when working with cold liquid, solid, or vapor
- Safety glasses are recommended when handling high-pressure cylinders and in areas where vapors are discharged

Set-up gas cylinder in a well ventilated area. Keep cylinder away from sources of heat. Storage should not be in heavy traffic areas to prevent accidental knocking over or damage from passing or falling objects. Valve caps should remain on cylinders not connected for use. Segregate full and empty cylinders. Storage areas should be free of combustible material. Avoid exposure to areas where salt or other corrosive chemicals are present. Install carbon dioxide cylinders with the valve end up. See Compressed Gas Association Pamphlet P-1 for additional recommendations.

8.19.3 Installation Safety Recommendations

Preventive Measures

The very first preventive measure is to inform all persons who handle or who use inert gases:

- Of the hazard represented by the refraction of oxygen in atmosphere
- Of the preventive means to be employed in handling the gases
- Of procedures to be observed should an accident occur

This information and training should be systematically and periodically reviewed in order to maintain an awareness with regard to these hazards. In particular, training in rescue work is fundamental since quickly improvised rescue, without the respect of a strict procedure, often proves to be ineffective, if not catastrophic (the rescue worker lacking foresight becomes a second victim). An annual program of training and rescue drills is recommended.

Ventilation

Depending on the existing ventilation, amount of gas used and size of room where the unit is installed and operated, ventilation may be required. A local exhaust may be useful at the point of sources of possible gas vapors. Where low lying areas are not naturally ventilated vents should be situated to avoid higher than normal concentration. Hazards to be considered in confined spaces are:

- Limited access and exits
- Increased likelihood of gas accumulation through leaks
- Increased asphyxiation risk
- Fire and explosion hazard

To be considered as confined spaces are the inside rooms of a building, laboratory rooms, machine pits, culverts, basement trenches for piping. When working in confined spaces, it is advisable that operators and other personnel are fully aware of the hazards of oxygen deficiency and adopt the following practices:

- A fully documented permit to work system
- Personal and fixed oxygen analyzers
- Self contained breathing apparatus available for use and all personnel fully trained in its use
- Personnel harnesses and ropes
- Operation of the "buddy system"
- A system of fresh air ventilation and fume extraction

In the case of permanent presence of personnel in a room where there are risks of oxygen depletion mixture, ventilation must be maintained with at least 30mJ per hour per person. The volume of air introduced per hour must not be less than twice the enclosed space in question. Ventilation should never be carried out with pure oxygen, but solely with air.

Testing of Oxygen or Gas Content

At present, various types of oxygen analyzers are available, which are often simple and reliable to operate. Such a monitor should at least have

- A readout of the actual gas concentration
- A settable alarm threshold value
- An alarm output with an acoustic and optical alarm connected
- An error output that shows malfunction of the monitor

Ideally the monitor should be placed so that it can be read inside, as well as from outside, the room which has gas present. The selection of the type of apparatus depends on the nature of the work in the place to be monitored (temperature, multiple detectors, portable equipment, etc). The picture below shows such a monitor for CO₂.



Testing the oxygen content is desirable, although attention must be drawn to the fact that an analyzer alone is not absolute protection. Such equipment can always malfunction, unexpectedly be out of adjustment or detectors can be improperly positioned. Testing of oxygen content should therefore only be considered as an aid to the detection of a lack of oxygen.

Work Permit

For certain types of work, safety instructions and a special work procedure must be set up in the form of a work permit

Personnel Protection

Depending on the type of work to be performed, and the layout of the premises, the decision to provide additional protection for personnel may be taken on the initiative of the person in charge. Such additional protection may involve:

- The use of notices warning against the presence of a hazard
- The placing of a person on watch outside the work area
- The use of personal atmosphere monitors
- The organization of an alarm system for rapid intervention in case of an emergency
- The wearing of a harness so that the worker can be easily and rapidly taken out of an enclosed space in the case of an emergency. Preferably this harness is connected to a hoist to facilitate removing the victim. It is very difficult for one man to lift up another in the absence of a hoist.
- The wearing of an autonomous breathing mask, to the exclusion of all cartridge masks, which are ineffective in a case of lack of oxygen.
- The wearing of protective goggles and gloves when handling liquid nitrogen to avoid burns
- The wearing of all other means of protection, such as safety shoes, helmet, etc., depending on the circumstances

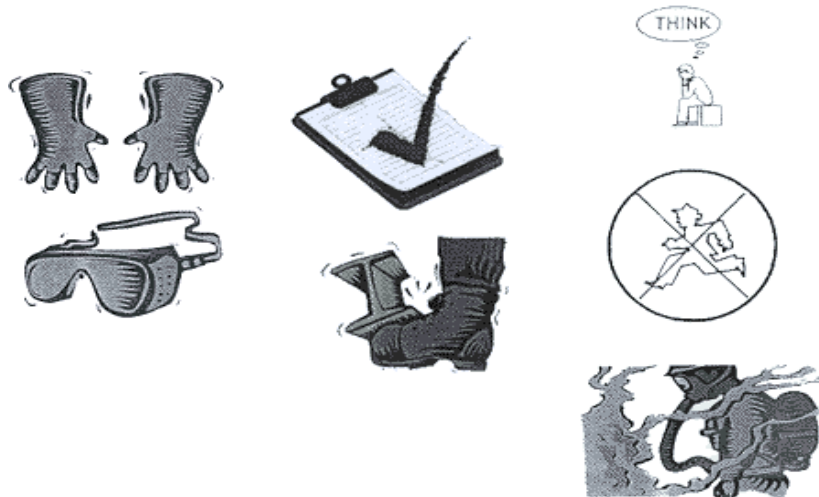

Considering the hazards mentioned above, it is essential to provide all those who handle or use inert gases with all the information and training necessary regarding safety instructions, means of prevention and procedures to be followed to avoid accidents, as well as rescue procedures to be implemented in the event of an accident.

8.19.4 Gassing System Installation

On installations preferably choose pressurized cylinders rather than gas wall outlets. The use of cylinders will limit the amount of gas being spilled in case of fatal failure. Whenever a wall outlet installation is chosen, make sure that there is a remote shut off valve installed outside the room where the gas is used.

Place the cylinder in an easily accessible and visible place next to the system. Remember that the cylinder will have to be replaced or refilled routinely. As the operator will have to check the cylinder routinely it should be clearly visible to all personnel during routine work.

The room should provide a glass door or a window that will allow a good view of the instrument and gas connection from outside the room. Often major defects can easily be detected by visible vapor clouds or icy tubes without the risk of entering a contaminated room.

Before installation make sure that the maximum specified inlet pressure is never exceeded. Always install a main shut-off valve that will cut gas flow as close to the source as possible. Secure cylinder when in use.



WARNING!

- Gas cylinders are under extremely high pressure that must be reduced for use with a StoreX incubator
- Use a pressure-reducing regulator when connecting to lower pressure piping system
- Never exceed maximum specified inlet pressure
- Never connect a Kiwi gassing inlet directly to a pressurized cylinder or wall outlet

Use a two stage pressure regulator with indicating valves. The high pressure gauge should have an indicating range of 0 to ~200 bar (0..3000 psi) to monitor the pressure or the gas source. For CO2 a scale of 0..100 bar (0..2000psi) is sufficient. The low pressure gauge should have an indicating range of 0..4 bar (0..60 psi) and will monitor the input pressure to the Kiwi Store. A flow meter is recommend since it will show correct operation of the system.

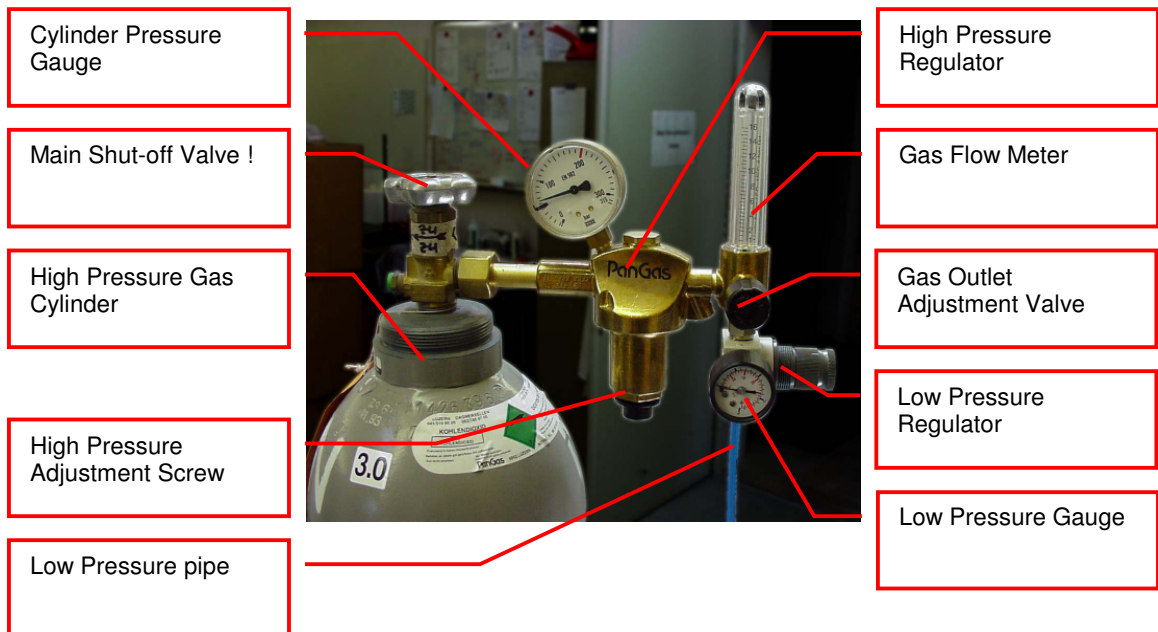

Two-stage pressure regulators are available from gas suppliers or laboratory accessories suppliers. The picture above shows an example of an installation. There is a wide variety of different models available. Your equipment may look different.

The gas inlet of the Kiwi Store is located on the back of the instrument. Attach the low pressure hose securely to the fitting. Always use the security nut. Never operate the unit without the security nut being tightly fit.

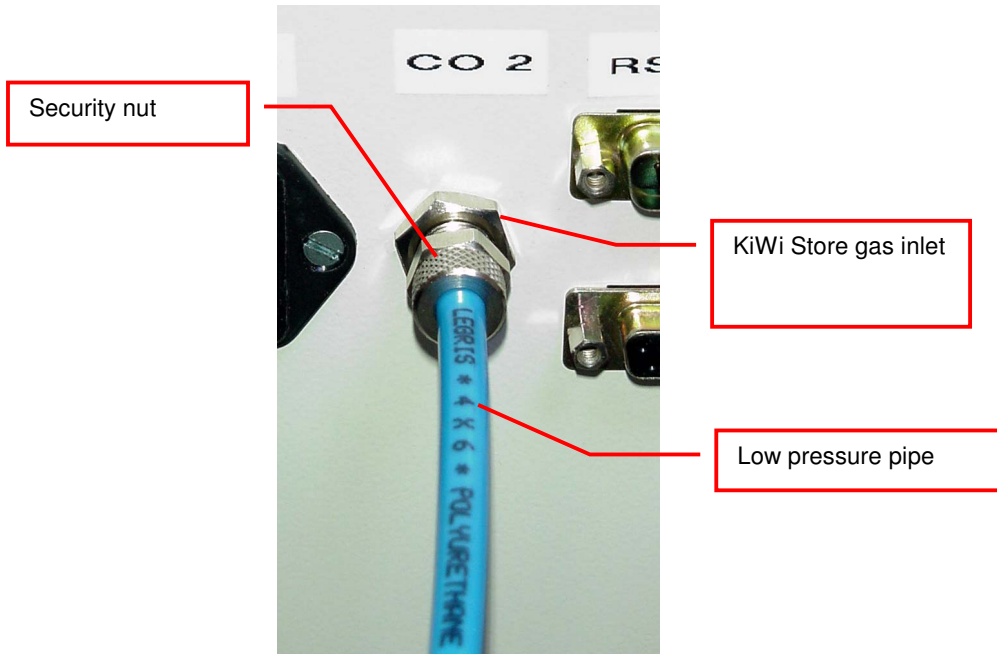

Use 4x6mm PUR, PVC, Neoprene or Nylon tube for the low pressure connection or in case of liquid nitrogen backup option a cryogenic safety tubing. Do not use Silicon or natural rubber tubing. Make the low pressure tube long enough to allow a minimum of movement of the gas cylinder for cleaning and maintenance work. For longer length of tubing, copper or other metal tubing should be considered. Foresee flexible tubing next to the instrument.

Be prepared for the following gas consumption values. These values may vary significantly over time since they depend on the instruments use.

8.19.5 Specific Advice for CO2 Carbon Dioxide

Principals of Operation

CO2 is mainly used as backup cooling for the KIWI DF STORES. CO2 allows to maintain the temperature at -20°C .



WARNING !
<ul style="list-style-type: none"> ➤ Improper use of CO2 or improper installation of the CO2 operated equipment may cause death ➤ Read CO2 safety information and installation instructions (See CO2 Installation) carefully. If you are not familiar with the handling of CO2 and / or safety precautions contact trained personnel.

Properties of Carbon Dioxide

Carbon dioxide is colorless and odorless as gas or liquid. It is stored in containers under its own vapor pressure. If the pressure is suddenly relieved, the liquid rapidly cools as it evaporates and sublimates, forming dry ice at -78.5°C (-109.3°F)

Boiling Point @ 1 atm	-78.5°C , -109.3°F
Freezing Point @ 1 atm	-56.6°C , 76.0°F
Vapor Pressure @ 20°C	56.5 atm, 831 psi
Solubility in Water @ 20°C , 1 atm	87.8% vol.
Specific Gravity (air =1) @ 20°C , 1 atm	1.53

Health Hazard Data of Carbon Dioxide

Carbon dioxide is a minor but important constituent of the atmosphere, averaging about 0.03% or 300 ppm by volume. At higher concentrations it affects the respiratory rate. Additional symptoms are described below.



WARNING !
➤ THRESHOLD LIMIT VALUE TLV = 5'000 ppm
➤ TLV-STEL (Short Term Exposure Limit) = 15'000 ppm (=1.5% vol.)

Carbon dioxide does not support life and may produce immediately hazardous atmospheres. At a concentration in excess of 1.5%, carbon dioxide may produce hyperventilation, headaches, visual disturbances, tremor, loss of consciousness and death. Symptoms of exposure in the concentration ranges of 1.5-5% may be highly variable, but typical symptoms of carbon dioxide intoxication include the following:

CO ₂ Concentration	Symptoms
3-6%	Headaches, dyspnea, perspiration, breathing increases to approximately four times normal rate, symptoms of intoxication become evident, and slight choking may be felt.
6-10%	Headache, dyspnea, perspiration, tremors, visual disturbance, characteristic sharp odor noticeable, very labored breathing and ringing in the ears, judgment may be impaired, followed within minutes by loss of consciousness.
Over 10%	Unconsciousness occurs more rapidly above 10% level. Prolonged exposure to high concentrations may eventually result in death from asphyxiation.

If the concentration of carbon dioxide exceeds 10%, unconsciousness can occur without warning, preventing self-rescue. At much higher concentrations, carbon dioxide displaces the oxygen in air below levels necessary to support life.

Persons suffering from the toxic effect of carbon dioxide should be moved to areas with normal atmosphere. Self contained breathing apparatus may be necessary to prevent toxic exposure or asphyxiation of rescue workers. Assisted respiration and supplemental oxygen should be given if the victim is not breathing. Frozen tissues should be flooded or soaked with tepid water ($105-115^{\circ}\text{F}$; $41-46^{\circ}\text{C}$). Do not use hot water. Cryogenic burns which result in blistering or deeper tissue freezing should be seen promptly by a physician.

8.19.6 Specific Advice for N2 Nitrogen

Properties of Nitrogen

Nitrogen is colorless, odorless and tasteless, as gas or liquid. It is nontoxic and non-flammable at atmospheric temperatures and pressures. A specific gravity of 0.9669 makes nitrogen slightly lighter than air. Nitrogen is mainly found in the atmosphere, where it accounts for 78.1% by volume of the air we breath. It is stored In containers under its own vapor pressure.

Boiling Point @ 1 atm	-195.8°C (-320.4°F)
Freezing Point @ 1 atm	-209.9°C (-345.8°F)
Vapor Pressure @ 20°C	150 atm
Solubility in Water @ 0°C, 1 atm	2.3% vol.
Specific Gravity (air =1) @ 20°C, 1 atm	0.97

Health Hazard Data of Nitrogen

Nitrogen is inert and does not sustain life. Nitrogen is nontoxic, but may cause suffocation by displacing the oxygen in air.

Oxygen Concentration	Symptoms
21 - 14% (<19.5%) Oxygen	Increasing pulse rate, tiredness, dizziness, drowsiness, excess salivation, diminished mental alertness
14 - 11% Oxygen	Muscular coordination slightly disturbed, intellectual performance becomes difficult, breathing and pulse rate increased
11 – 8% Oxygen	Possibility of headaches, nausea and vomiting, collapse or loss of consciousness.
< 6% Oxygen:	Unconsciousness occurs without warning and so quickly that the individuals cannot help or protect themselves. Convulsive movements, possible respiratory collapse and death or brain damage

On sudden pressure release, liquid nitrogen rapidly cools as it evaporates and sublimates, forming dry ice at extremely cold temperatures of -196°C (-320°F) at atmospheric pressure. This can cause **severe frost bite**.



WARNING !

- Nitrogen may cause suffocation by displacing the oxygen in air. Ensure levels of *at least 19.5% Oxygen*
- On evaporation Nitrogen forms dry ice at *extremely cold* temperatures of -196°C (-320°F)

Nitrogen may cause mild skin irritation, moderate eye irritation and possible gastric distress. Cause of chronic illness is not known.

On vaporization Nitrogen expands by a factor of 700; one liter of liquid nitrogen becomes 0.7 cubic meter (24.6 cubic feet) of nitrogen gas. This can cause the **explosion** of a sealed container, or it can displace oxygen in the room and cause **suffocation without warning**. Nitrogen can also become oxygen enriched and cause ordinarily noncombustible materials to burn rapidly.

In case of an accident evacuate all personnel from the affected area. Persons suffering from lack of oxygen should be removed to fresh air. If victim is not breathing, use trained personnel to administer a supplemental oxygen supply and

artificial respiration to support vital functions. If breathing is difficult, administer oxygen. Victim and rescuers must seek immediate medical attention.

Ventilate area and attempt to shut off the release of gas by tightening the main valve. If it is not possible to stop the release of gas, allow the gas to be released there. If leaking from cylinder or its valve, contact your supplier. Monitor area for a minimum of 19.5% oxygen content before allowing re-entry by personnel.

In case of frostbite, restore tissue to normal body temperature, 37°C (98.6°F), followed by protection of the injured tissue from further damage and infection. Immediately place the frostbitten part in warm water (not to exceed 40°C) or wrap affected parts gently in blankets. Under no circumstances should the water be over 44°C (112°F), nor should the frozen part be rubbed either before or after re-warming. Remove or loosen clothing that may constrict blood circulation to the frozen area. In case of massive exposure, remove clothing while showering the area with warm water. Encourage victim to gently exercise the affected part while being warmed. Call a physician. The patient should neither smoke, nor drink alcohol.

8.19.7 Backup Refrigeration installation

On installations preferably choose pressurized liquid gas storage cylinders rather than wall outlets. The use of cylinders will limit the amount of gas being spilled in case of fatal failure. Whenever a wall outlet installation is chosen, make sure that there is a remote shut off valve installed outside the room where the liquid is used.

Place the cylinder in an easily accessible and visible place next to the system. Remember that the cylinder will have to be replaced or refilled routinely. As the operator will have to check the cylinder routinely it should be clearly visible to all personnel during routine work.

The room should provide a glass door or a window that will allow a good view of the instrument and gas connection from outside the room. Often major defects can easily be detected by visible vapor clouds or icy tubes without the risk of entering a contaminated room. If this is not possible a oxygen level meter with a remote alarm needs to be installed creating a acoustic and optical alarm in case of low oxygen level.

Before installation make sure that the maximum specified inlet pressure is never exceeded. Always install a main shut-off valve that will cut gas flow as close to the source as possible. Secure cylinder when in use.



WARNING!

- Never operate a damaged liquid gas cylinder
- Special pressure-reducing regulator may be required to operate a liquid gas backup.
- Never exceed maximum specified cylinder pressure
- Always ensure tight fit of all connections.

Supplied connection for liquid gas backup is a 1/2" SAE male (outside thread). For liquid gas cylinder such as Cryogenic cylinders, standard connection hose are available.

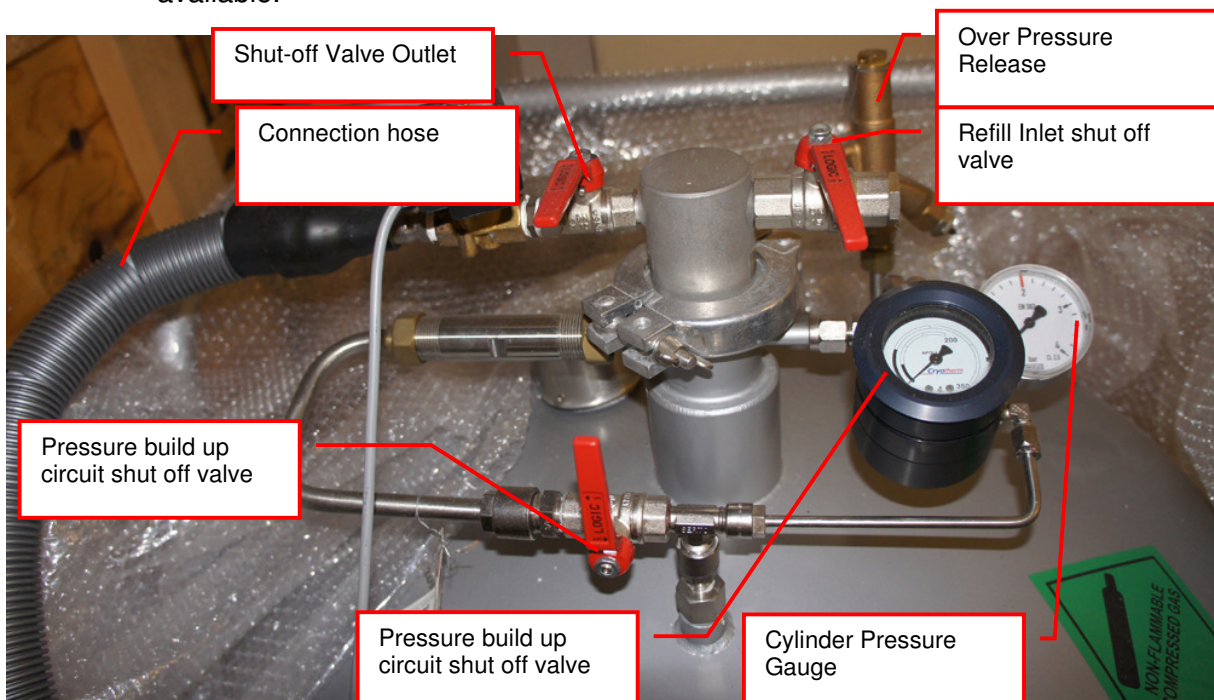

8.19.8 Specific Advice for LN2 Liquid Nitrogen

Properties of Nitrogen

Nitrogen is colorless, odorless and tasteless, as gas or liquid. It is nontoxic and non-flammable at atmospheric temperatures and pressures. A specific gravity of 0.9669 makes nitrogen slightly lighter than air. Nitrogen is mainly found in the atmosphere, where it accounts for 78.1% by volume of the air we breath. It is stored In containers under its own vapor pressure.

Boiling Point @ 1 atm	-195.8°C (-320.4°F)
Freezing Point @ 1 atm	-209.9°C (-345.8°F)
Vapor Pressure @ 20°C	150 atm
Solubility in Water @ 0°C, 1 atm	2.3% vol.
Specific Gravity (air =1) @ 20°C, 1 atm	0.97

Health Hazard Data of Nitrogen

Nitrogen is inert and does not sustain life. Nitrogen is nontoxic, but may cause suffocation by displacing the oxygen in air.

Oxygen Concentration	Symptoms
21 - 14% (<19.5%) Oxygen	Increasing pulse rate, tiredness, dizziness, drowsiness, excess salivation, diminished mental alertness
14 - 11% Oxygen	Muscular coordination slightly disturbed, intellectual performance becomes difficult, breathing and pulse rate increased
11 – 8% Oxygen	Possibility of headaches, nausea and vomiting, collapse or loss of consciousness.
< 6% Oxygen:	Unconsciousness occurs without warning and so quickly that the individuals cannot help or protect themselves. Convulsive movements, possible respiratory collapse and death or brain damage

Spills of liquid Nitrogen have extremely cold temperatures of -196°C (-320°F) at atmospheric pressure. This can cause **severe frost bite**.



WARNING !

- Nitrogen may cause suffocation by displacing the oxygen in air. Ensure levels of *at least 19.5% Oxygen*
- Liquid Nitrogen has *extremely cold* temperatures of -196°C (-320°F)

Contact with liquid Nitrogen may cause skin frost burns and severe eye damages.

On vaporization Nitrogen expands by a factor of 700; one liter of liquid nitrogen becomes 0.7 cubic meter (24.6 cubic feet) of nitrogen gas. This can cause the **explosion** of a sealed container, or it can displace oxygen in the room and cause **suffocation without warning**. Nitrogen can also become oxygen enriched and cause ordinarily noncombustible materials to burn rapidly.

In case of an accident evacuate all personnel from the affected area. Persons suffering from lack of oxygen should be removed to fresh air. If victim is not breathing, use trained personnel to administer a supplemental oxygen supply and

artificial respiration to support vital functions. If breathing is difficult, administer oxygen. Victim and rescuers must seek immediate medical attention.

Ventilate area and attempt to shut off the release of gas by tightening the main valve. If it is not possible to stop the release of gas, allow the gas to be released there. If leaking from cylinder or its valve, contact your supplier. Monitor area for a minimum of 19.5% oxygen content before allowing re-entry by personnel.

In case of frostbite, restore tissue to normal body temperature, 37°C (98.6°F), followed by protection of the injured tissue from further damage and infection. Immediately place the frostbitten part in warm water (not to exceed 40°C) or wrap affected parts gently in blankets. Under no circumstances should the water be over 44°C (112°F), nor should the frozen part be rubbed either before or after re-warming. Remove or loosen clothing that may constrict blood circulation to the frozen area. In case of massive exposure, remove clothing while showering the area with warm water. Encourage victim to gently exercise the affected part while being warmed. Call a physician. The patient should neither smoke, nor drink alcohol.

8.19.9 Refill LN2 Liquid Nitrogen cylinder

When ever working with liquid Nitrogen use of personal safety equipment is required. Thermal gloves and protective glasses have to be worn at least.

Refill interval of LN2 cylinder is depending on the required minimum backup time and the available LN2 cylinder volume. All cryogenic cylinder have a certain leakage rate which will define the time after which the minimum filling level of the tank is reached. The filling level is shown by a gauge mounted next to the connection points on the cylinder. The actual design may vary depending on cylinder manufacturer.

Before disconnecting the connection hose close the pressure builder valve, the shut off valve on the cylinder and the shut off valve on the connection point on the actual storage chamber. Use two suitable spanner to loosen the connection on the chamber (or on the cylinder depending on refill procedure). Usually the cylinder is then moved to a refill station and refilled with LN2. Depending on cylinder manufacturer the process may vary. Please refer to the manufacturers cylinder manual for further details.

To reconnect the cylinder with the system, proceed in the reverse way to the disconnecting procedure. Connect back the hose. Open the main shut off valve on the cylinder, open the shut off valve on the storage chamber and open the valve on the pressure builder. The pressure builder valve has to stay opened in order to ensure proper operation of the LN2 backup option.



WARNING!

- Wear personnel protection when disconnecting, refilling and reconnecting LN2 cylinder.
- Ensure the shut off valves are closed when disconnecting the cylinder.
- Refer to cylinder manufacture manual for exact refill procedure



CAUTION !

- Shut off valve of pressure builder has to stay open as long as the cylinder is connected to the storage.

8.19.10 Refill LCO2 Liquid CO2

The refill procedure of the CO2 backup cooling is a relatively simple process as it only needs to be performed if the CO2 cylinder is empty. As the CO2 cylinder has no loss over time it has no regular refill interval.

When replacing a cylinder, make sure the shut off valve on the CO2 cylinder and on the unit are closed. Use a spanner to disconnect the pressure regulator from the bottle. Put the new bottle in place and reconnect the pressure regulator. Open the shut off valve of the cylinder and of the storage.



WARNING!

- Ensure the shut off valves are closed when disconnecting the cylinder.

Manual Operation

9. Power-On System

The instruments power is activated by the main switch. The instrument is turned on by pressing the power switch located at the front of the instrument. After power-on the climate portion of the instrument is activated automatically. An alarm will sound. If the green light of the power switch does not turn on, check the main switch at the back of the instrument or the fuse in the mains supply.

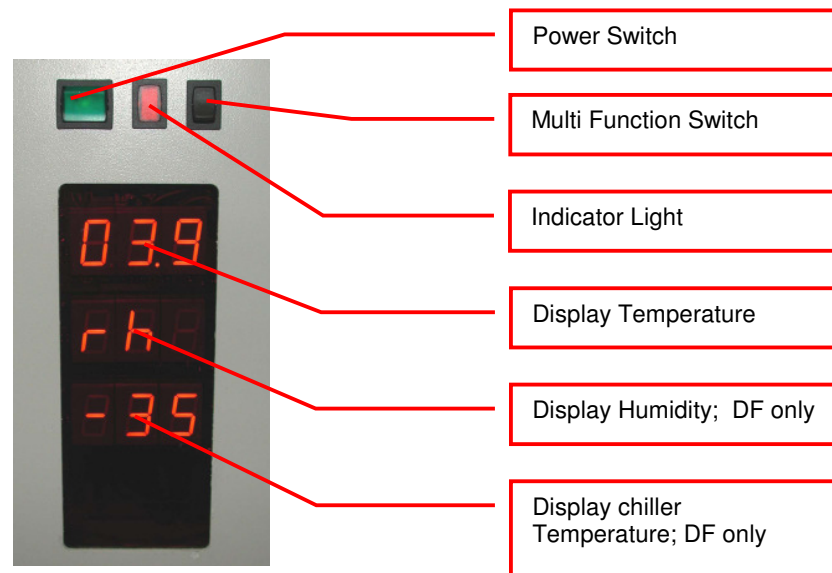

The alarm indicates that the handling is not activated. In order to activate the handling, the black multi function switch has to be pressed (Interface and STT only). The multi function switch will cause the handling to initialize. Take note the gate - if opened- is closed after pressing the multi function switch. Pressing the multi function switch is equal to sending an external activate command through the software.

It is normal for some condensation to occur during warm-up. This condensation will disappear once the internal climate is stabilized. The settling time may take several hours.

The temperature inside the climate chamber is displayed on the temperature display. The temperature display may not be used to set temperature. The operating temperature can only be set through the communication port.

Toggle Multi Function Switch	Function	Description
Toggle (< 1sec) (after power on)	Initialize	Unit initializes (Interface and STT only)
Toggle (< 1sec) (Unit initialized)	Carousel turns one position further	Carousel turns to the next cassette position. (Interface and STT1000 only)
Hold (Unit initialized)	Carousel turns	Carousel turns till switch is released (Interface and STT1000 only)
Hold in case of Alert (10sec)	Acknowledge Alert	Check system for cause of Alert

10. Doors

10.1 Front Door

The front door opens to the left side of the instrument and should be kept closed at all times. A handle keeps the front door closed, additionally the standard lock can be used. When an access is necessary it should be for as short as possible.

In order to avoid condensation and to allow an even temperature distribution inside the instrument, the front door is heated. Note: Leaving the front door open for extended periods will influence the instruments temperature.

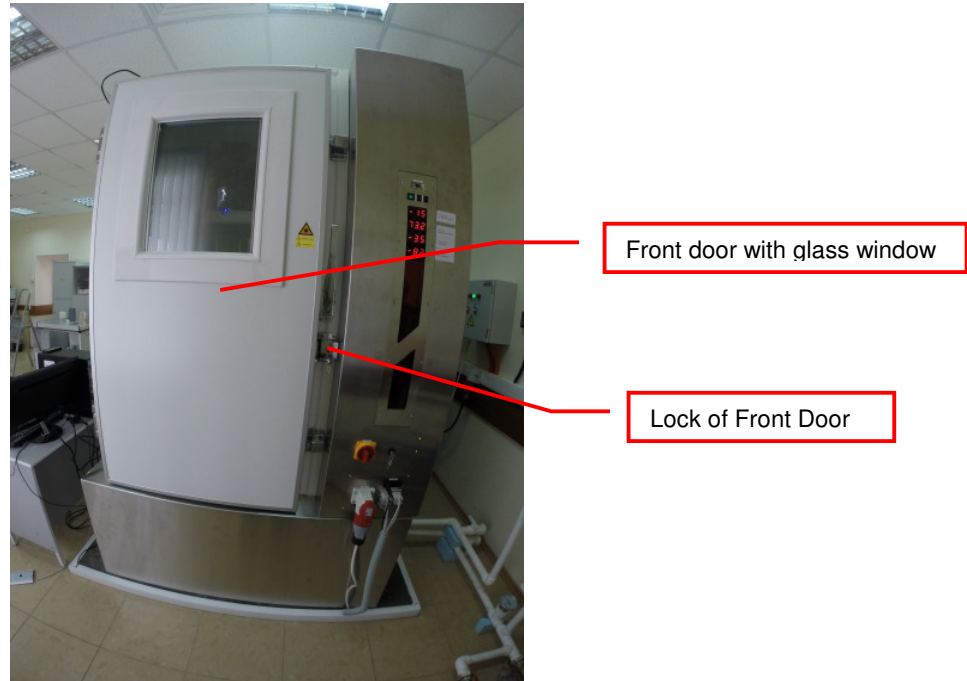

The front door is opened by pulling the handle on the right side and may be opened to an angle of almost 180 degrees.

Regularly inspect the sealing performance of the front door to avoid unwanted humidity intake and temperature variations.



CAUTION !

- Keep front door closed when it is not being accessed
- Keep front door access to a minimum



WARNING !

- It is dangerous to leave the front door open over long periods of time.
- Avoid excessive condensation on the glass window

10.2 The Robot Gate

The robot gate is located on the side of the Interface unit or on the user side of the unit. Through the robot gate the storage samples are transported by the handler. The robot gate has the same sealing system as the front door. Because of the frequent accessing through the gate, special care must be taken with the sealing performance of the gate.

The gate may make spontaneous movements. External commands, manual interaction and internal protection time-out functions may cause the gate to close. Special care must be taken that the gate cannot be accessed during operation.

**WARNING !**

- Remote Accesses have priority over manual accesses
- No remote access should be initiated during a manual access

The Gate movement is speed and force controlled. However, the high demands on the sealing capability of the gate require certain minimum forces, therefore there is a risk of injury. Never put hands into the gate opening when the instrument is active.

**WARNING !**

- The gate cannot be opened manually. Do not apply force to the gate.

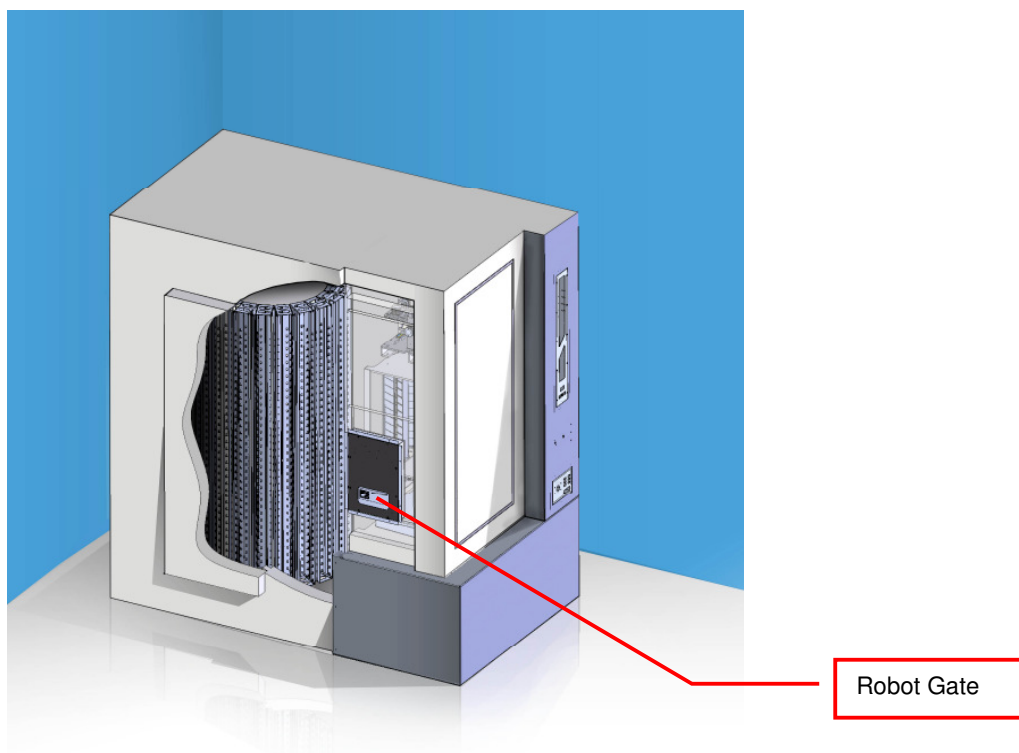

11. Buffer Cassettes

Cassettes allow simple and comfortable loading and unloading of storage samples and can be prepared outside the climate chamber. Once prepared, the samples can be quickly transferred into the climate chamber of the Kiwi unit.

There is a wide variety of cassette types available. Make sure that you work with the proper cassette size that matches the type of plates you are using.



CAUTION !

- Do not add, bend or remove support rails.
- If cassettes with different pitch height are used within the same system, make sure a prior removed cassette is put back in exactly the same position. Failures being generated like that, will in destinations not found or crashes.
- Only a trained System Integrator may alter the instrument configuration and reset the lift accordingly.

The cassettes are open at their front for loading.

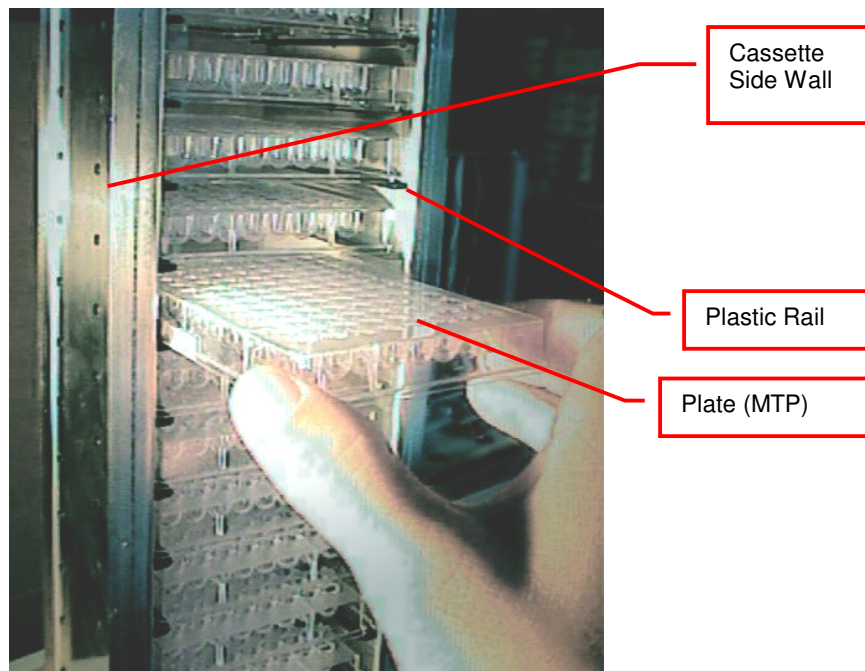

To put a plate into the cassette, choose the level and slide the plate along the rails towards the back of the cassette. Slightly lift the front of the plate to avoid excessive wear of the retaining nozzles at the front end of the rails. When the plates are loaded make sure that they are all pushed towards the back of the cassette. Plates that jut out may cause collision with the handler and may result in damage to the handler.

Cassettes must be treated with great care. They are aligned within 1mm when leaving the factory. Misaligned cassettes must be returned for re-alignment. Misaligned, tilted or bent cassettes may cause handling failures. Special care must be taken when cassettes are fully loaded with plates.

The carousel must be kept clean as particles may cause the cassette to tilt. Do not place cassettes on the floor as they may pick-up dust etc. Always store cassettes inside the climate chamber or on clean surfaces.

Use the cassette handle for transport of the cassettes. When lifting the cassette by its handle it will tilt backward slightly in order to prevent plates from shifting to the front.

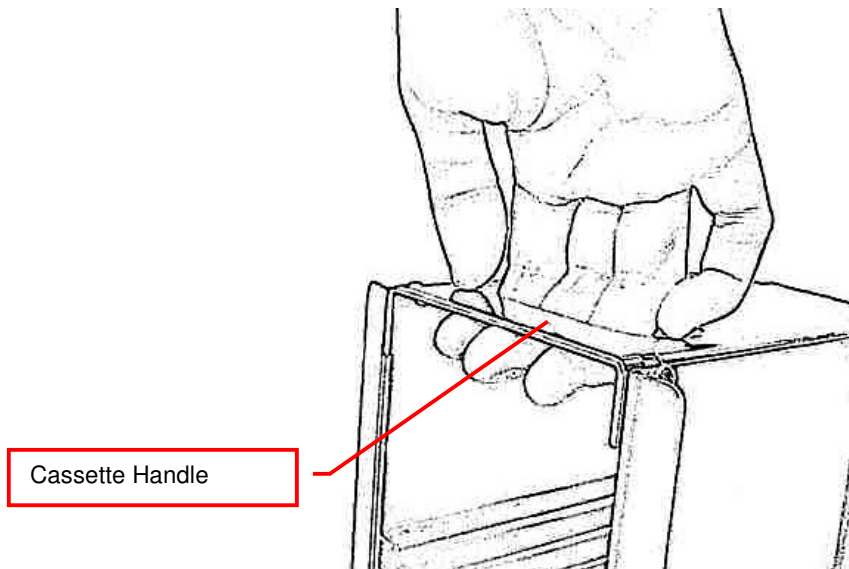

Never apply force to the cassettes. Do not drop a cassette as mechanical shock will misalign it. Never lift a cassette by its side walls. This may bend the side walls of the cassette. Bent side walls cause the plates to block when being loaded or unloaded.

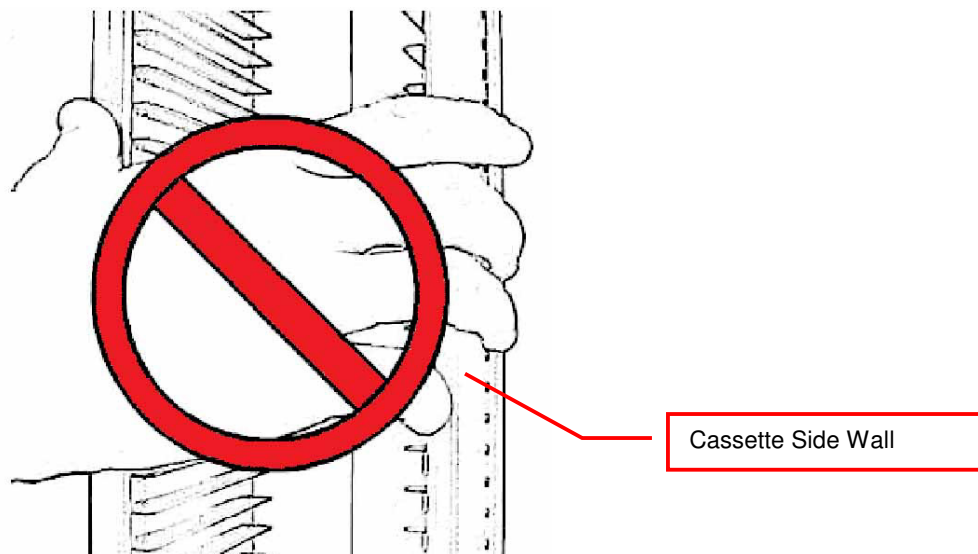

In the rare event of a blockage with the extended shovel in the cassette, the shovel must be carefully pushed backwards until it can move freely. Then the cassette can be removed.

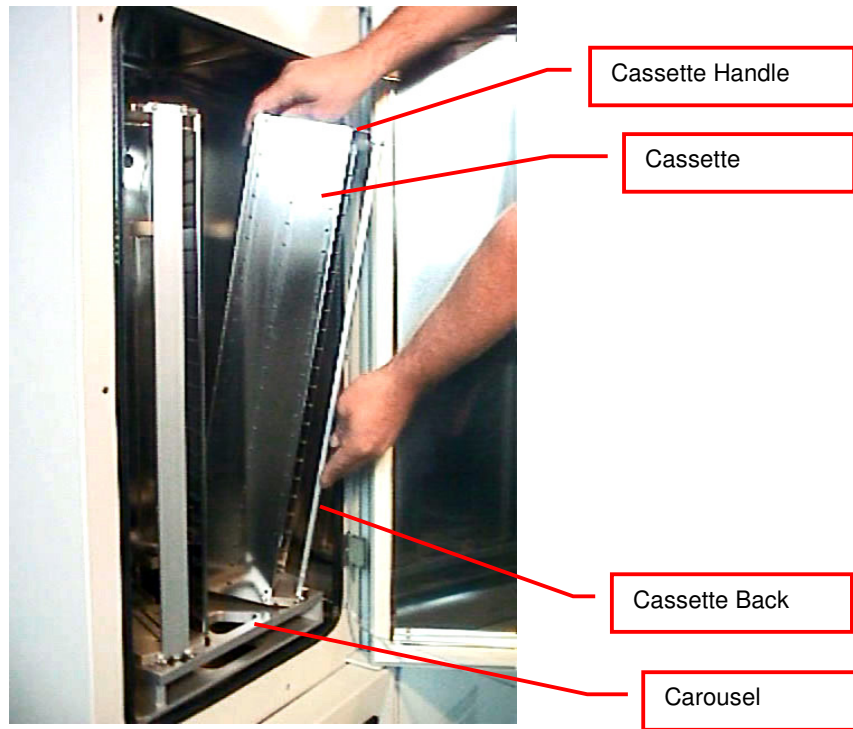

The cassettes are secured by alignment rails to the carousel. The cassettes may be tilted slightly backwards (towards the front opening) for removal. In order to load a cassette align the back of the stacker base plate to the cassette alignment rail. Push the cassette forward until it stands vertically. The cassette should now stand firmly on the cassette plate. There should be no movement.

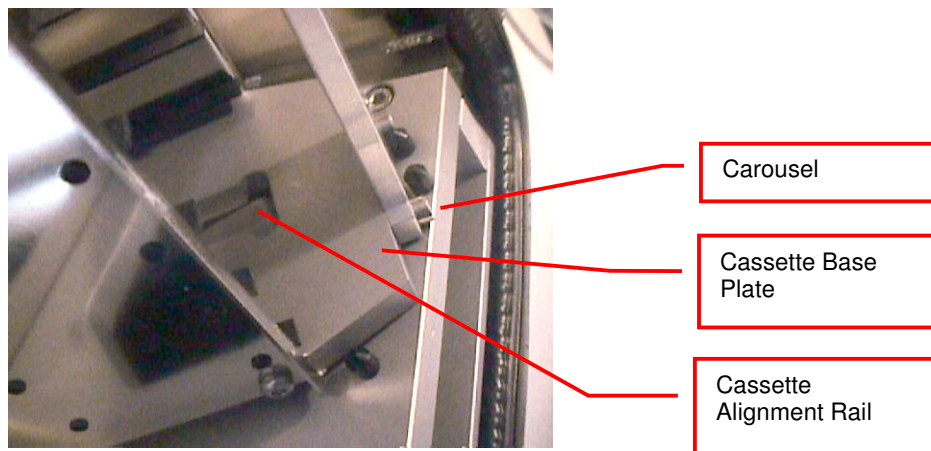

To remove a cassette pull the stacker handle slightly backwards, tilting it, then lift the cassette until it loosens from the cassette alignment rail. Use both hands for this operation. Never use force.



CAUTION !

- Make sure that ALL plates are pushed to the back of the cassette. Plates jutting out the front side of the cassette may cause collision with the handler shovel.
- Lift cassettes by their cassette handles only
- Do not drop cassettes. Misaligned cassettes can cause handling errors
- Do not autoclave cassettes with plastic rails. Use disinfecting solution for sterilization. All stainless steel cassettes may be autoclaved.
- Keep cassette plate clean. Particles may tilt cassettes

12. Barcode Reader

12.1 1D Reader for racks and plates

The Barcode reader for plate/rack identification is mounted onto the handling mechanism.

The Barcodes must be placed on the shorter side of the plates and must face towards the open side of the cassette. The barcodes should be parallel to the plate's lower edge. The barcode label should be centered both vertically and horizontally. On higher plates (e.g. deep well plates) place the barcode further down. Preferably barcode labels should be at the same height independent of the plate height. Barcode reading reliability is improved when the barcode is not covered by the plate's lid.



WARNING !

- Laser Class 2. Laser light - do not look into the beam.



DANGER !

- May be harmful to your eyes.

Use barcode testing device to verify barcode quality. Quality Class A, B or C are required. Identification of Class D is not guaranteed. For sufficient print quality use barcodes printed by thermal transfer or photographic methods. The barcode label surface should be mat and clean. Do not use yellowed, dirty or damaged barcodes

12.2 2D Rack Scanner / Reader

The 2D Scanner / Reader for tube identification is located in the interface unit.

The 2D codes must be placed on the bottom of the tube. The 2D reader operates either on a scanner or camera based principle. If a camera is used it requires lighting by short flashes to take pictures. These flashes may be a potential trigger for people with photosensitive epilepsy.



WARNING !

- A few people may experience epileptic seizures when viewing flashing lights or patterns. Avoid watching the 2D code reading for longer time.

Use barcode testing device to verify barcode quality. The code label surface should to be mat and clean. Do not use dirty or damaged barcodes.

13. Climate Settings

13.1 Temperature Settings

System Temperature is pre set. Temperature should only be changed by a qualified system administrator or LiCONiC engineer.

13.2 Humidity Settings

Humidity is kept as low as possible and is not adjustable.

14. Alert System

The KIWI STORE has a combined acoustic / visual alert system. An alert occurs when one or more abnormal statuses occur or when interaction is required. When the system is operating properly there is no alert. The various alerts are distinguished by the alert signal duration and the pause between the signals.

14.1 STT Alerts

The STT KIWI STORES are the out of the box storages. Therefore manual access is possible to the storage area. Below find the relevant alerts for STT1k5 :

Signal / Pause (time in seconds)	Alert	Comment, Action
0.1 / 2.4	No Initialization	StoreX not initialized. Press Multi Function Switch for initialization.
0.1 / 0.3	Gate Timeout	Check Handling position. Press Multi Function Switch to close Gate.
0.2 / 0.4	Front Door Timeout	Close Front Door or press Multi Function Switch to cancel alert status.
0.5 / 0.5	Access collision	Occurs when Front Door is opened and shovel is extracted. This alarm indicates high risk of damage to the handler. Do not rotate carrousel. Check shovel position before moving cassettes. Use extreme caution as shovel may be trapped in a cassette.
0.1 / 0.1	System Busy Access	Front Door is opened during a remote access. Close Front Door and wait for remote access to be finished.

15. Routine Safety Checks

Carefully read all safety instructions before operating the instrument. Be sure that you fully understand their content. Although the KIWI STORE is intended to be operated as a remote controlled system, there still are some manual interactions required for operation. Apart from these operations there are also some very important safety checks the operator should be familiar with.

The operator should regularly read the display readings and check whether they match the desired values. Readings like "0.00" or "9.99", readings that are far out, instable or that differ over long periods of time could indicate a malfunction of the instrument or could be caused by faulty settings of the system.

The electrical cables should be routinely inspected for wear, defects or contusion. There should be no mechanical tension on any cable. Broken connectors should be replaced immediately. All electrical installations should be kept clean and well protected from water and humidity.

The same applies to cables and gas tubing. They should be free of mechanical tension and should show no signs of wear or contusion. Sharp bends should be avoided under all circumstances. All fittings should be secured. Missing security nuts must be reinstalled immediately. Any broken pneumatics parts must also be replaced immediately.

The mechanical appearance of the instrument should be clean and "straight". All movements should be smooth and precise. Watch out for unusual noises as these may indicate misalignments or mechanical wear.

Seals should close the chamber firmly. Check seals by placing a piece of paper between the seal and door. When trying to pull on the paper, there should be an even resistance. Check the seal on the glass door, gate and front door.

Condensation, mainly on the front glass door, presents a possible severe danger as it may lead to water flowing into the electrical parts of the instrument. When cooling, excessive condensation on the glass door will occur when the front door is open over a long period of time. Furthermore it may also indicate a faulty heater or high environmental humidity.

Icing on a gassing tube or on a pressurized gas cylinder indicates excessive gas flow and therefore severe danger. Once icing has been observed leave the room immediately and call for help. Do not try to locate the source of the problem or try to fix it. The room may already be contaminated.



WARNING !

- Icing on the gas cylinder or other parts of the gassing system indicate excessive gas flow.
- In the case of such icing leave the room immediately and call for help
- Do not try to locate the source of the problem or try to fix it

Software

16. Sample Management Software

16.1 Order File

The order file is used to retrieve specific samples from the storage system. Two types of order files can be used to execute order jobs. The first type is the simple order file containing only 1D or 2D codes or ID's of tubes/racks to be retrieved. The second type is more complex, allowing more functionality. Refer to the following chapter for a detailed description of the files.

16.1.1 Simple order file

In case of the simple order file, the file is a simple list of 1D barcodes for plate orders only. For tube orders 2D barcodes/Sample ID's, or a mixture of both can be used. These files can be passed onto the system as CSV (Comma Separated Values) file or as a TXT-File using the web interfaces LoadJobList -page. They can be populated manually by a user or exported from MS Excel© or a database. Picture 1 below shows an example of a simple order file for tube picking.

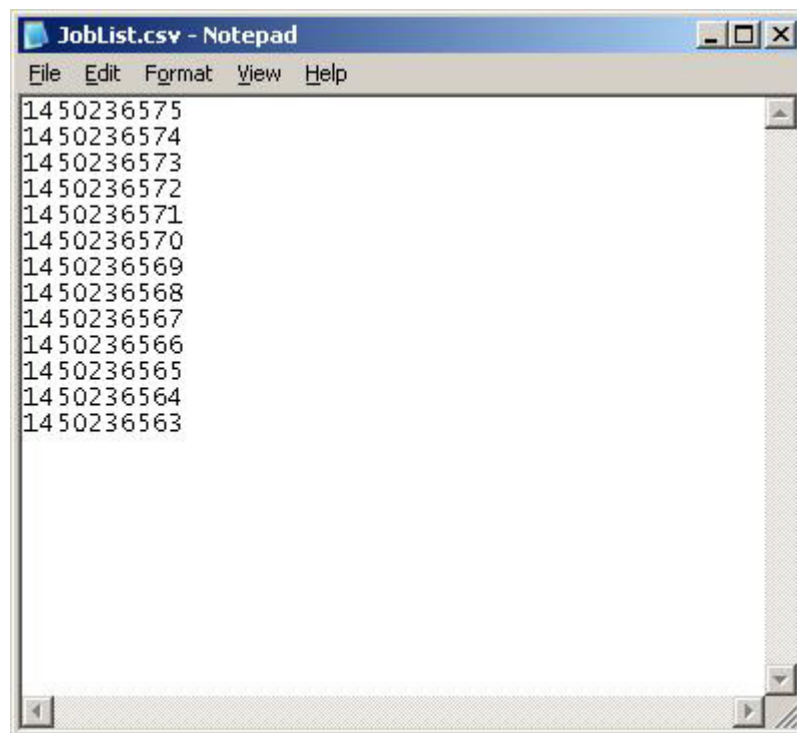

Picture 1: Sample order file

16.1.2 Complex order file

In case of the complex order file, the file consists of a parameter list. This file can be passed onto the system as a CSV (Comma Separated Values) file or as a TXT-File. The file can be populated manually by a user or exported from Excel® or a database too. Picture 2 below shows an example of a complex order file.

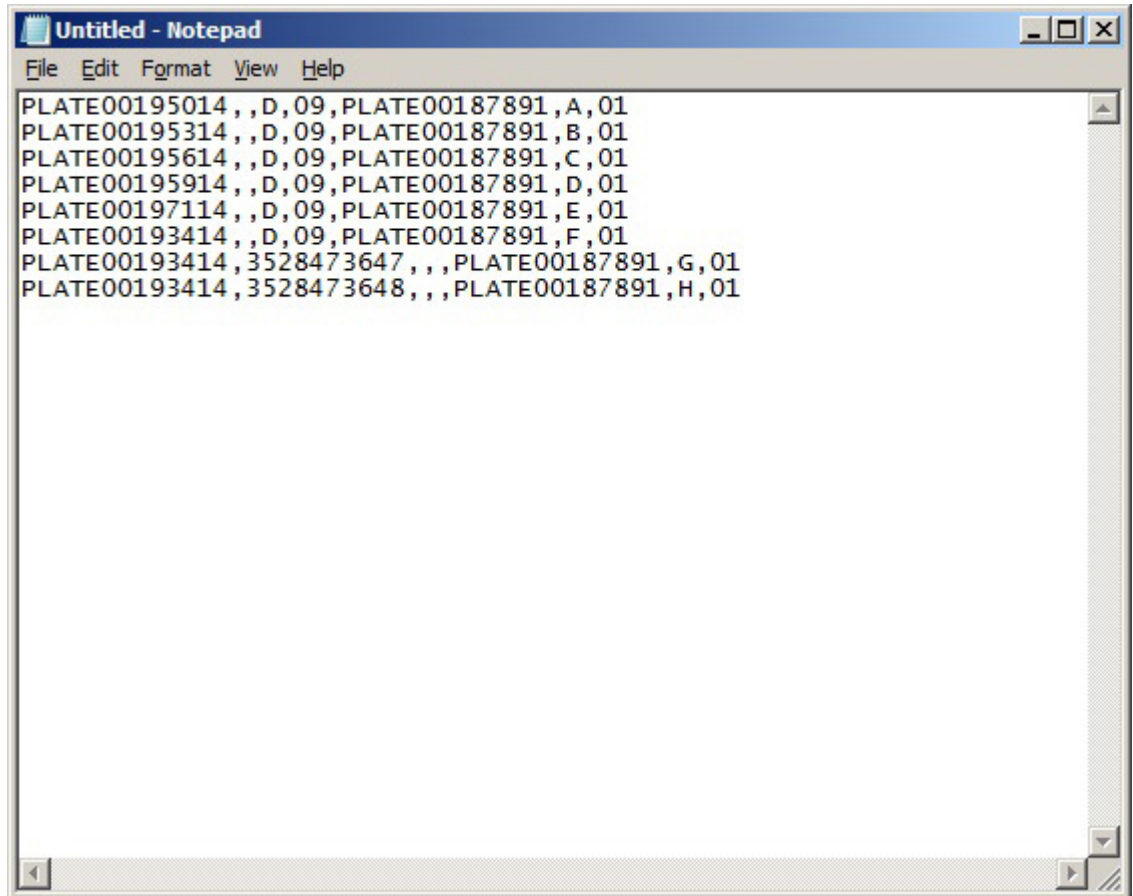

Picture 2: Complex order file

A parameter line consists of the following items:

- Barcode(1D) or explicit name of the source rack,
- Barcode(2D) or explicit name of the tube to be picked,
- Row of the picked tube on the source rack,
- Column of the picked tube on the source rack,
- Barcode(1D), explicit name or generic name ("Rack_1,"...) of the target rack,
- Row of the picked tube on the target rack,
- Column of the picked tube on the target rack

16.2 Web-Interface

The Web-Interface supplies an easy to use and intuitive GUI. There are two different GUI's depending whether you would like to place an order from a remote computer, or if you would like to retrieve/store your samples.

In the following chapters a description of the different GUI's is given with instructions how to use them.

To access the unit on the remote or local GUI an authorization is requested (Picture 3: User Identification). Access management and user rights will be discussed further on in the PlateExplorer section.

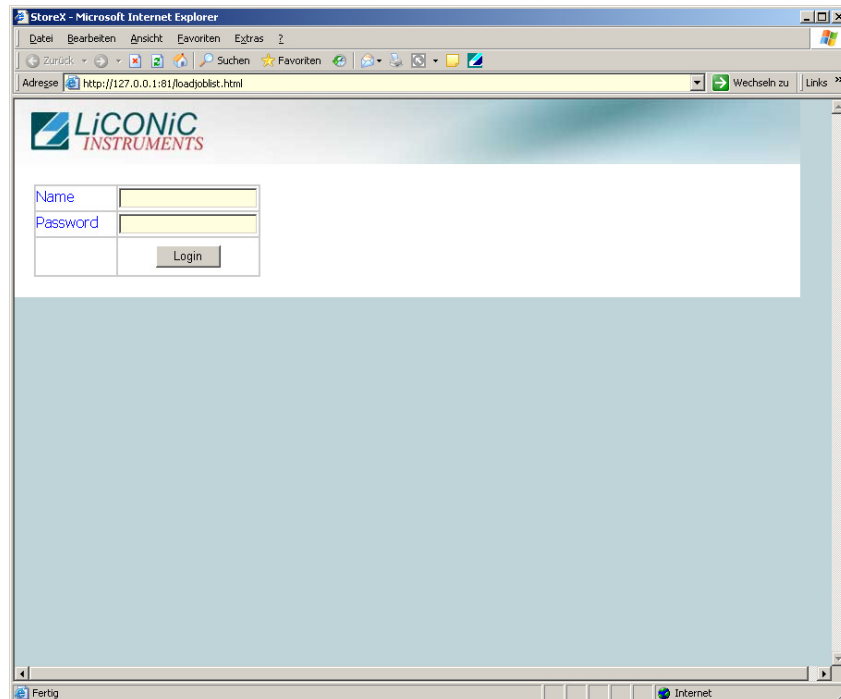

Picture 3: User Identification

16.2.1 Remote Web Access

Placing an order is most likely performed from a remote computer. In order to do so the user needs to open the browser, type in the name of the Kiwi-PC following loadjoblist.html (example: <http://MyKiwiPc/loadjoblist.html>) and to log in. To then send an order to the system the “Search” button has to be pressed to select the desired file. This will open up a dialogue box to search your local computer for an order file. Select the desired order and click open. The file path will be displayed next to the “Search” button. With pressing the “Send File” the order is passed to the system.

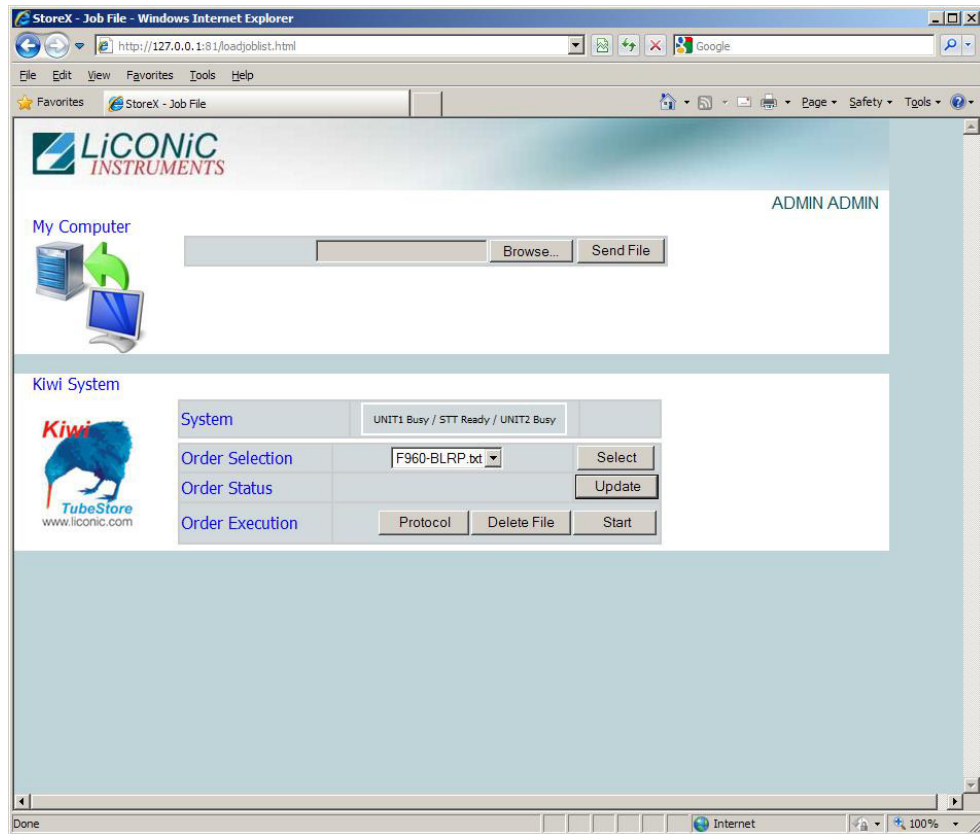

Picture 4: Remote order placement

To start the order, the required file needs to be selected from the drop down menu and the button “Select” needs to get pressed. This being done, the “Start” button will start the processing of the order. When the order is started it will be displayed as shown in Picture 4 including the approximate time till the order is finished. The user now can make use of the “Update” button in order to see the current status of the job. Additionally in this screen selected jobs can be deleted by pressing the “Delete” -button.

Since the system is a multi user system, other users are able to submit orders at the same time. If this happens, the submitted order will be placed in a queue ready for processing once the current order is complete. The processing follows the “First come first serve” principle. This is dependant on the priority of the order assigned. When accessing to the unit one can always check the current status of the orders. Pressing the “Update” button the GUI will refresh the display and show the most recent information. The progress of the order selected in the “Select Job” area will be shown. The bar shows a relation between the amount of lines in the jobfile and the ones already being processed.

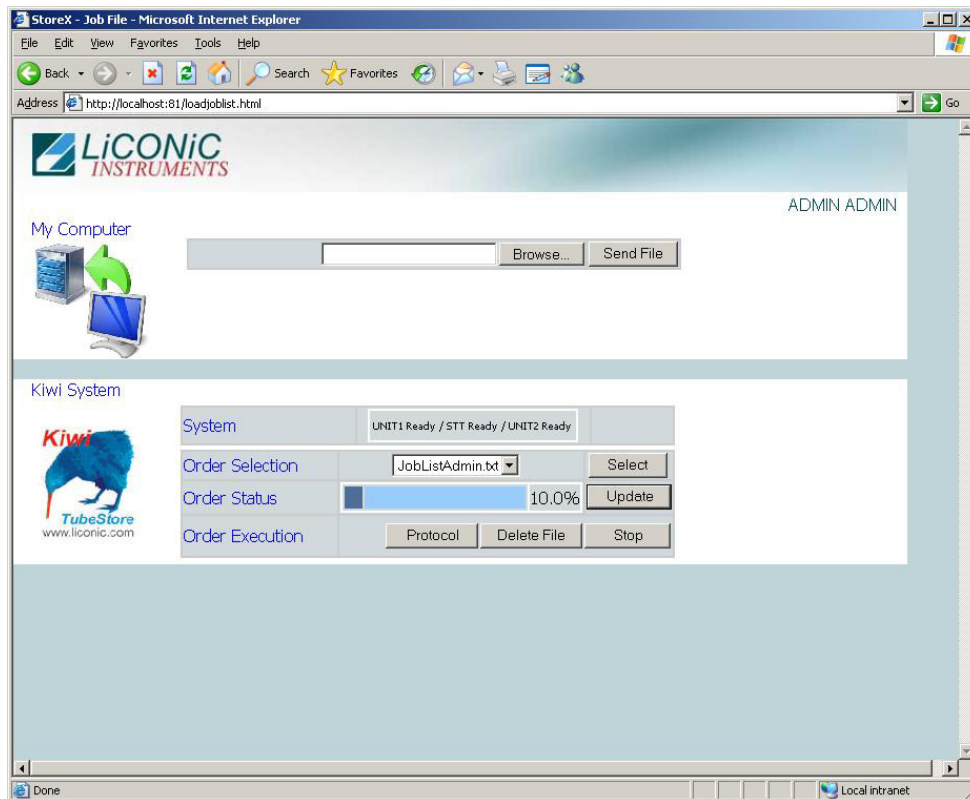

Picture 5: Order selection for status display

16.2.2 Local Web Access

The local Web-Interface is only usable when the user is in front of the unit. The two main functions are Plate import and Plate export.

Plate Import

When loading a new Plate the user first needs to generate an XML content file. On the Import/Export Interface in the section “Plate Content” one then needs to press “Browse”, to choose the desired file and then press “Load”. By then the system imports the file data including the plate’s 1D-code. When pressing “Import”, the plate gets moved into the storage device using 1D –barcode authentication (See Picture 6).

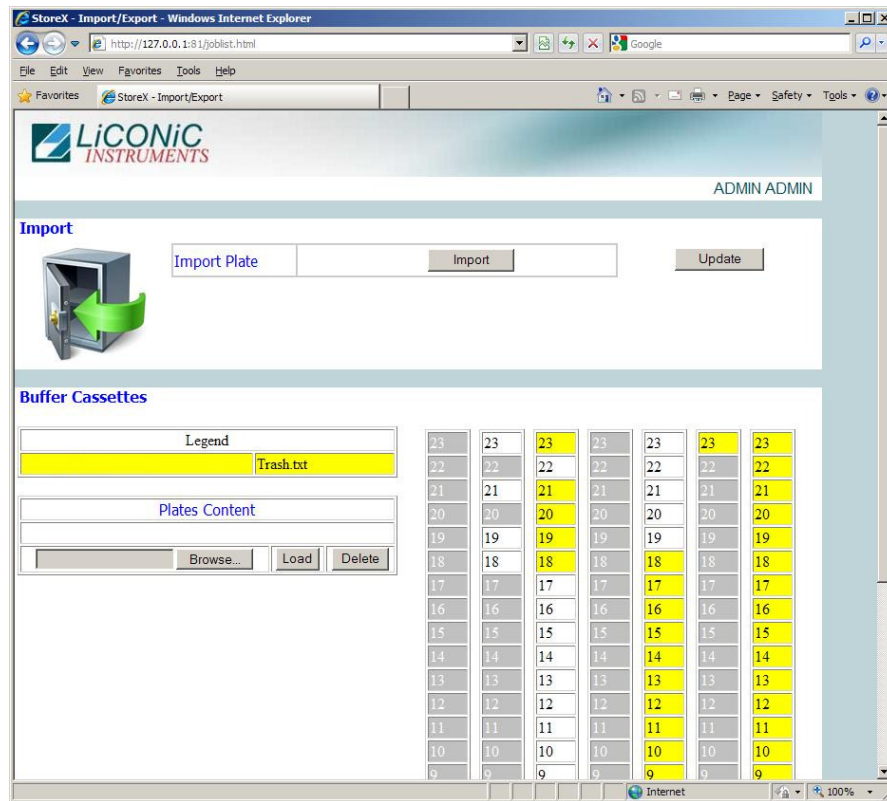

Picture 6: Local plate/rack import/export screen

Plate Export

Plates can be exported when finished orders are complete. In general by then the plates are stored in the bigger store compartment of the Kiwi-device. In order to move them into the interface compartment, one needs to figure out the name of the job and choose either “one plate” or “all plates” from the table on the bottom of the Import/Exports web interface. Having done so, pressing the “Export” button will start the move of the plates into the interface. To finally move them out, using the transfer station, one needs to identify the plates of the job being done by either the name or the color to be compare to the table on the left (see Picture 6). To move a plate out, it needs to get clicked once and then the user needs to choose “Unload” from the Right-Click-Menu of the plate. Depending on the system configuration the plates have to be requested one by one (only one transfer station available) or can be stored into an I/O-buffer. If the system is built with an I/O buffer (for bigger systems this is mostly the Interface unit) the whole order can be exported to the buffer, providing the job’s amount of plates is smaller or of the same size as the buffer.

16.3 PlateExplorer

The PlateExplorer is the more sophisticated administrative access possibility to the Storage system. It allows the manager and the user access to it. Therefore the PlateExplorer has two different access levels in general.

The PlateExplorer is a network based application and can run therefore on a remote computer over the network. Before using the application every user has to log on. (Picture 7) The application will automatically log off a user after a certain idle time, (this time can be adjusted).

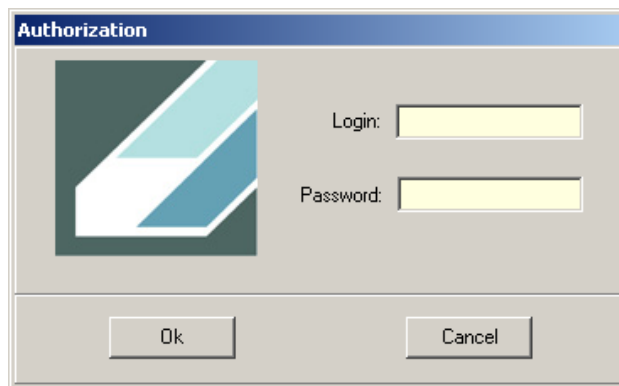

Picture 7: The PlateExplorer's login window

16.3.1 General Functionalities

In this chapter the functionality accessible to the administrator and the normal user are described. There is only one difference between user and administrator. Whilst the user has only access to the assigned area, the administrator has access to the full store. Therefore the difference will not be mentioned in this part of the manual anymore.

Drag&Drop

The **Drag&Drop** functionality of the PlateExplorer makes this GUI very simple to use. Plates and Racks can be moved within the store by simply left-clicking them, keeping the mouse button held and release it over the desired location.

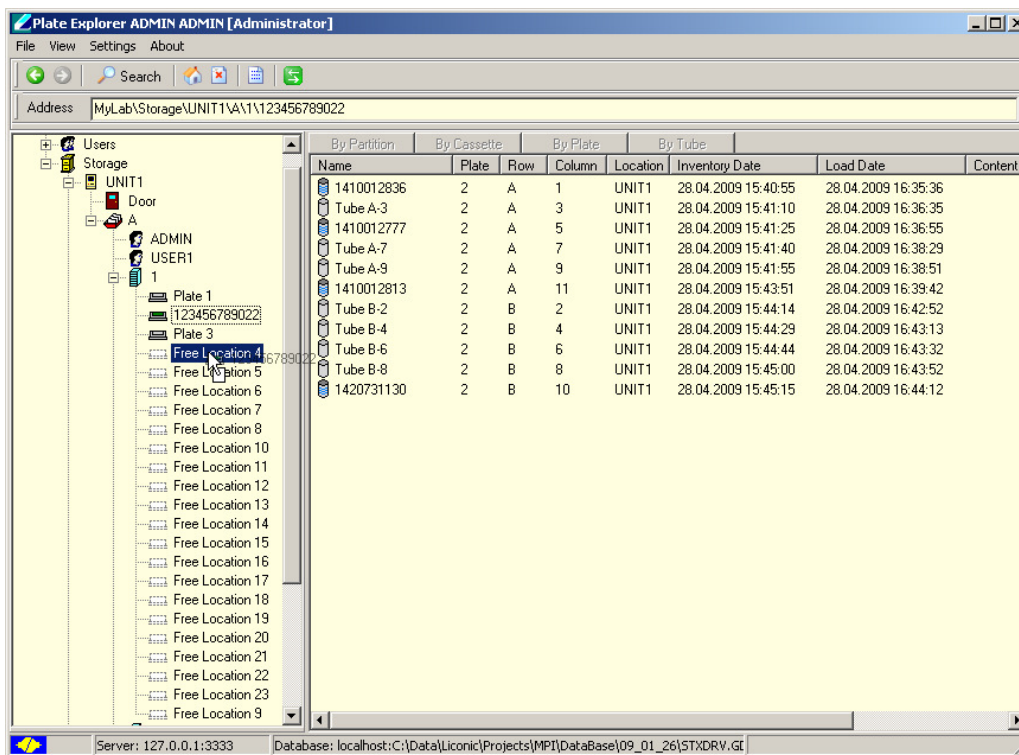

Picture 8: Drag&Drop a plate

To manually move a tube, the tube racks first have to be moved to the Picker/Boxer. In the “Location” view (selected in the menu bar “View”) of the picker/boxer the tubes can conveniently be localized. For a single tube the easiest way to move it, is to Drag&Drop (hold CTRL in parallel) it.

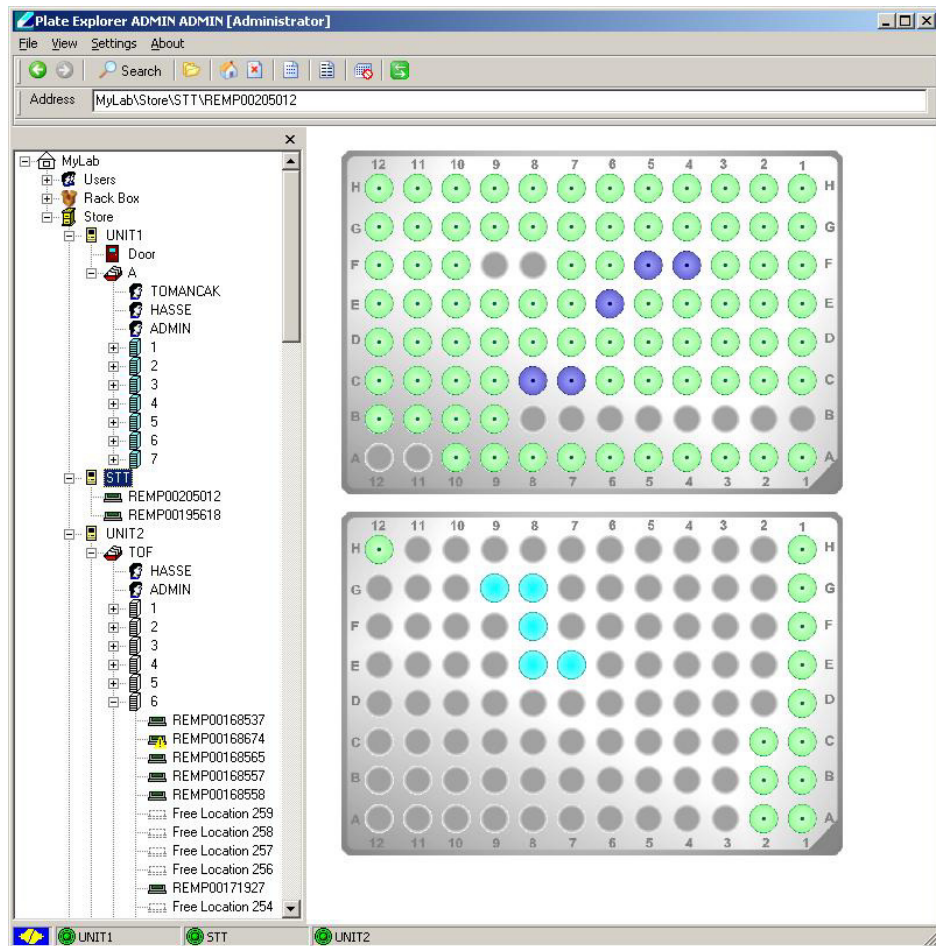

Picture 9: Copy&Paste a tube

Copy&Paste

If more than one tube is to be moved, the Copy&Paste -method is more convenient (see Picture 9). To use this functionality one can click on different tubes on the source side holding the CTRL-button in parallel, then right-click one and choose "Copy". Afterwards one can choose the target locations the same way and insert the tubes by right-clicking again and choosing "Paste".

16.3.2 Layout of the PlateExplorer

The main window of the PlateExplorer is subdivided into the Menu bar, a quick usage button bar, the contents tree on the left and the detailed information view on the right (see Picture 10).

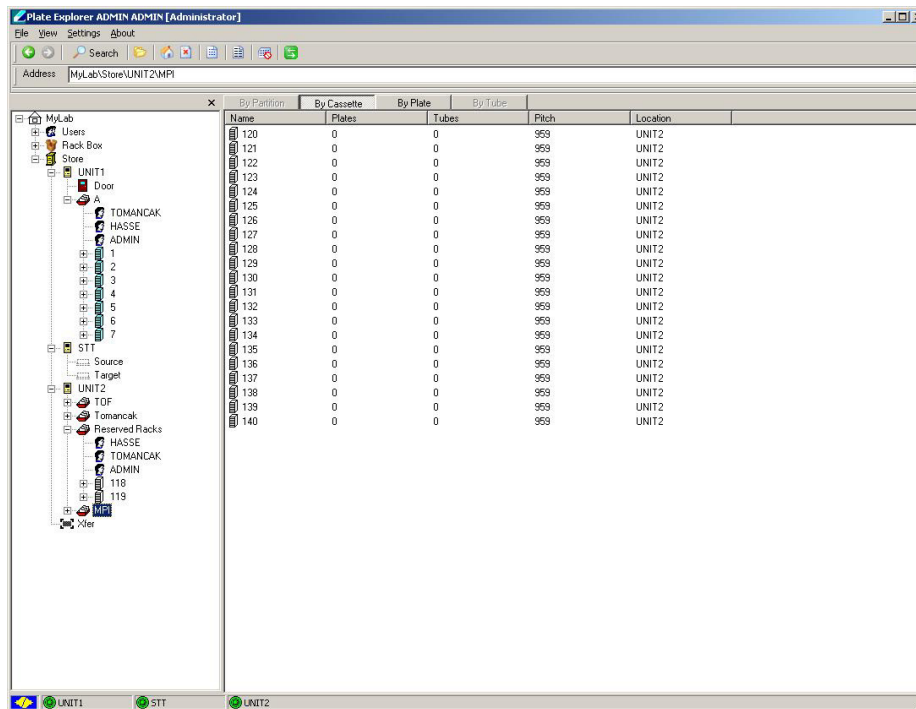

Picture 10: Main screen of the PlateExplorer

The Menu Bar

The menu bar of the PlateExplorer covers four main entries.

The “*File*”-menu item offers the user to “Exit” the program.

The “*View*” options enable the user to define the way to look at the items being displayed in the PlateExplorer’s Detail View on the right. The user can choose between a “List” mode, “Small icons”, “Symbols” a “Detailed View” and a so-called “Location View”. The last is mostly used to better visualize tube movement when plates are on the picker/boxer.

The “*Settings*” come with the ability to change the details on the “Connection” (Here the IP address/name and the port of the computer running the STXGui.exe have to be set), the Logout Delay can be set (“Security” – “Logout Delay”), the “*Database*” of the PlateExplorer can be assigned in the belonging entry and global “*View*” settings for the software can be set (“Show history”, “Sort Levels”, “Tool bar” and “Status bar”).

The “*About*” window will show information on the running PlateExplorer software.

The Icon Bar

The icon bar of the PlateExplorer shows different buttons that will be explained here.

The *navigation arrow* buttons on the left enable the user to do steps forward and backwards in the navigations being made.

The *search button* calls the search function. With the search function (Button with the magnifying glass) the content of the store can be searched. The search is also available in the right-click menus. Using it in that way, the user can decide about the level within the tree structure the search will take part in and exclude the rest (click open the tree up to the level you want to search, right-click there and choose it from the menu). In Picture 11 and Picture 12 examples are shown.

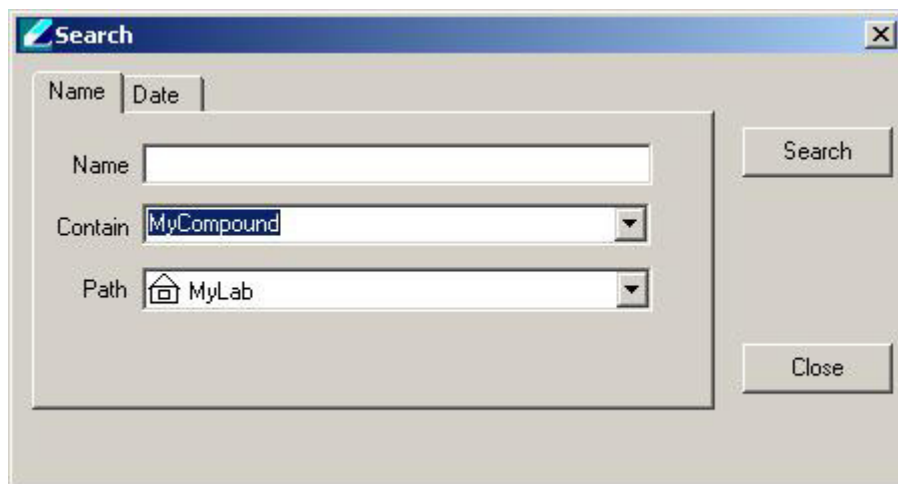

Picture 11: Search for Sample ID or Barcode

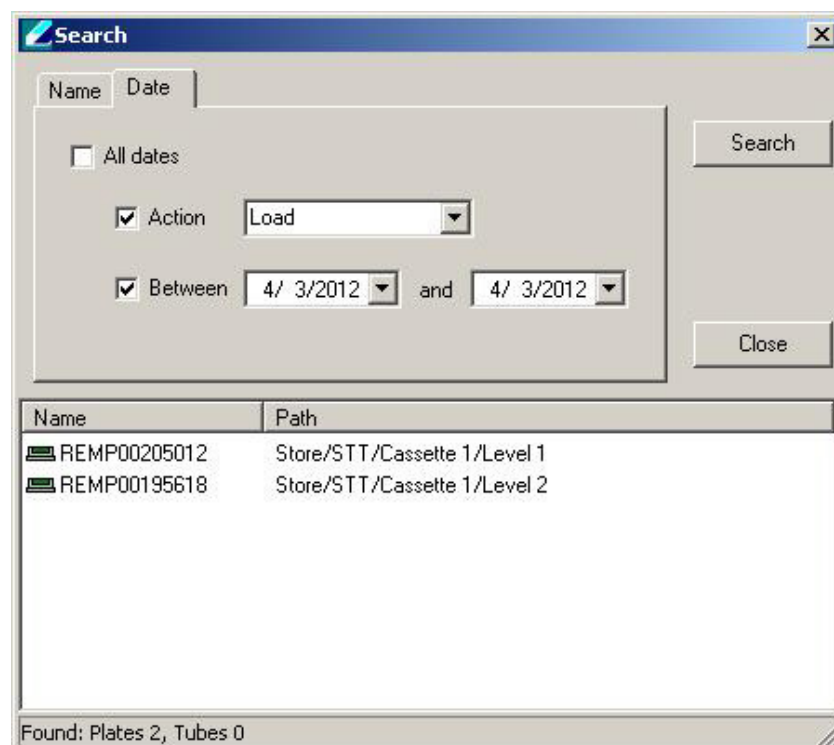

Picture 12: Search by date with results

The generated search results can be used to create an order file as described in section 1.1. This can be done by holding CTRL and clicking onto the desired items. Right-clicking then will offer the user “Save as a Job File” (see Picture 13). This can be processed via the Web-Interface afterwards.

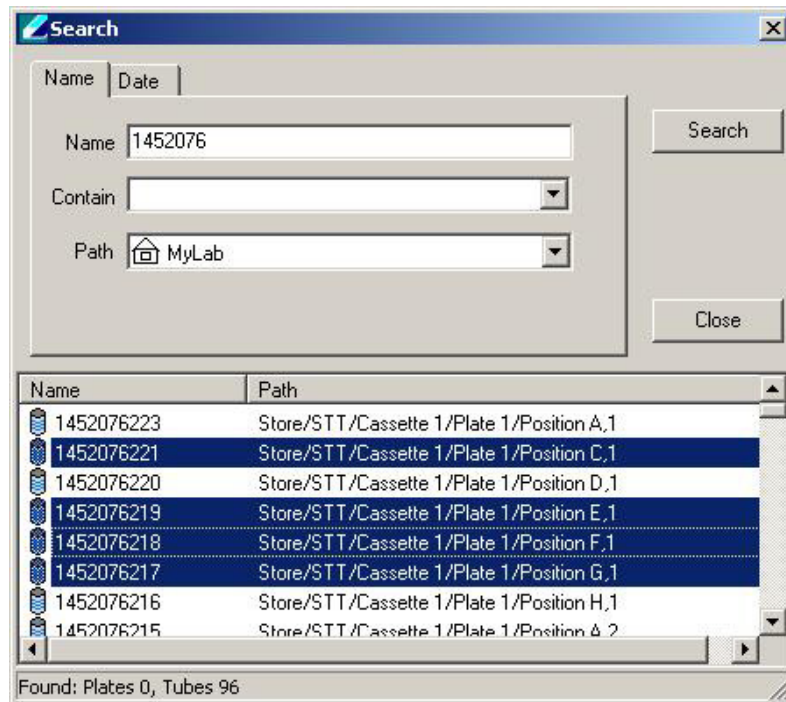

Picture 13: Create an order from search results

The *folder* button enables or disables the tree view on the left.

The *home symbol* button actualizes both detail windows (tree view and detailed view on the right) and closes the tree in the tree view on the left.

The button with the *cross symbol* is used to disconnect from the system.

The *dotted sheet* button will show the jobfile history, means pick jobs of the past and current ones. Further it integrates error statistics.

The *lined sheet* button is used to show current Import and Export options. The “Import” tab shows the actually loaded import files and enables the user to delete them by using the “Delete” button. The “Export” tab shows jobs that have been processed and are ready to export. Those can be deleted the same way too.

The *plate with stop* button raises a search interface that enables the user to look for tube racks with certain amounts of usage times for locations within the rack. This functionality is commonly used to figure out, which racks are old enough to substitute them and thus make sure, that boxed tubes are not falling through it when being used with it.

The *green arrows* button is used to log the current user out of the system.

The Address Bar

The address bar of the PlateExplorer shows the user the current location the PlateExplorer is within the tree hierarchy in a path form.

The Tree Window

The tree window of the PlateExplorer shows the user the current location the PlateExplorer is within the tree hierarchy. Here registered users and rack types as well as the physical (sub units, picker and Xfer station) and logical (partitions) structure within the LiCONiC storage device and its belonging access rights (users within the tree) are visualized.

“Users” shows all users being registered for within the database for web and application access.

The “Rack Box” is a visualization of rack types that are registered within the device. Those can be dragged and dropped onto the transfer station to start an import of a rack into the system via the PlateExplorer software. The user will then be asked where the rack will be loaded and what its content is.

The “Store” symbol finally is the actual Kiwi device visualization. It is subdivided into further units (mostly Unit1 [Storage -80°C area], STT [Picker/Boxer] and Unit2 [Interface -20°C area]) and the transfer station. The subunits themselves show their *door status* (if installed) and the *partitions* being installed by the user. The *picker/boxer* only will show its two positions for the source and the target rack.

Within the partitions, which can be seen as logical sub-divisions of the Kiwi, one can see the so called cassettes, vertical hanging shelves within the unit. Their single positions, called levels, form the lowest hierarchy level.

When being filled with a rack they can have different states. If the graphics label is *grey*, it means that no tubes are in there. If a *green* label appears, the system shows that the rack is either partially or completely filled. Is the rack *crossed out with a red line*, the system has no 1D-barcode assigned to it.

An *exclamation mark* shows that the plate is assigned to an export job and not accessible to retrieve tubes from it. The question mark marks that the systems auto inventory is enabled and the plate hasn’t been inventoried yet. Grayed and crossed out levels showing the level being blocked for security reasons. This level is not accessible to store plates into it.



Picture 14: Rack symbols in the Tree View

The Detail Information Screen

The detail information screen on the right of the PlateExplorer shows the user all properties of the item selected within the tree view on the left. It supports Drag&Drop and its functionality can mostly be accessed with the help of the right-click action menus. Those will be explained within part 1.3.4 of this manual.

16.3.3 Setting up the Plate Explorer

The Administrator access level of PlateExplorer is intended to manage and administer the store. It allows the management of user rights, storage and troubleshooting. The initial values for the Login per default are “ADMIN” with “test”. Please change that as soon as you have access to the software.

Setting up the Database- and Driver Connection

In order to get the PlateExplorer working with an existing firebird database and a running STXGui.exe –driver, the user needs to fill out two forms within the PlateExplorer. The first is located under “Settings” and “Database”. Here the settings to connect to the belonging database have to be made. As server type the user can choose between “Local” and “Remote”. If “Remote” is chosen, the user needs to type in the IP address or name of the server. In both cases the database-file including the path needs to get chosen.

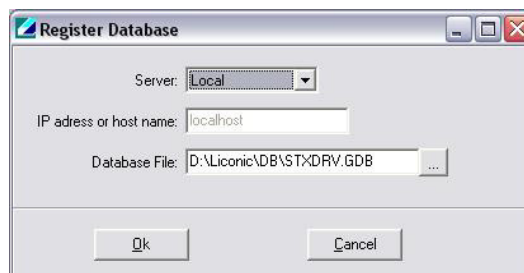

Picture 15: Database Connection Settings

When the database is chosen, the user can connect to the running driver of the actual machine. In order to do so, click “Settings” in the menu bar and choose “Connection”. Then type in the name or IP address of the STXGui.exe –driver server and the belonging port (default 3333).

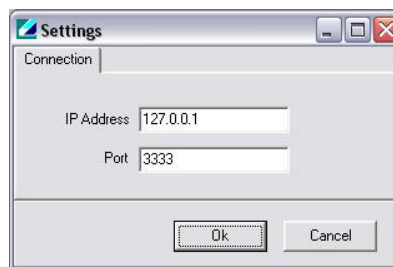

Picture 16: Driver Connection Settings

After this has been done, the PlateExplorer should be able to connect and should offer to initialize the sub units.

User Management and Alarm notification

The Administrator mode allows the creation, modification and deletion of users and their rights. In the picture below (Picture 17) the “User Manager” is shown. All users accessing to the system have to be created with this tool, even users accessing only through the Web-Access. The initial user data for accessing the User manager are the user “SYSDBA” with the password “masterkey”.

To access the tool, please mark “Users” and right-click and select “User Properties”. After logging in twice, press the “New User” button to create a new user. A new line will be shown on the right hand side and the dialogue boxes on the left will get editable. Now a login name, password, the users name and mail details have to be assigned. Additionally the Administrator here needs to assign the partitions the user is allowed to work with. The partitions are storage areas within the unit. A user can have access to only one or multiple areas. Details how to create partitions will be given further on.

After all information is entered, the “Save” button has to be pressed to finally store the user and their details.

To edit a user the desired user is selected from the list on the right and the “Edit” button pressed. The fields on the left side will get editable. Change the information and press the “Save” button to store the changes made. When finished, press “Close” to close the user manager.

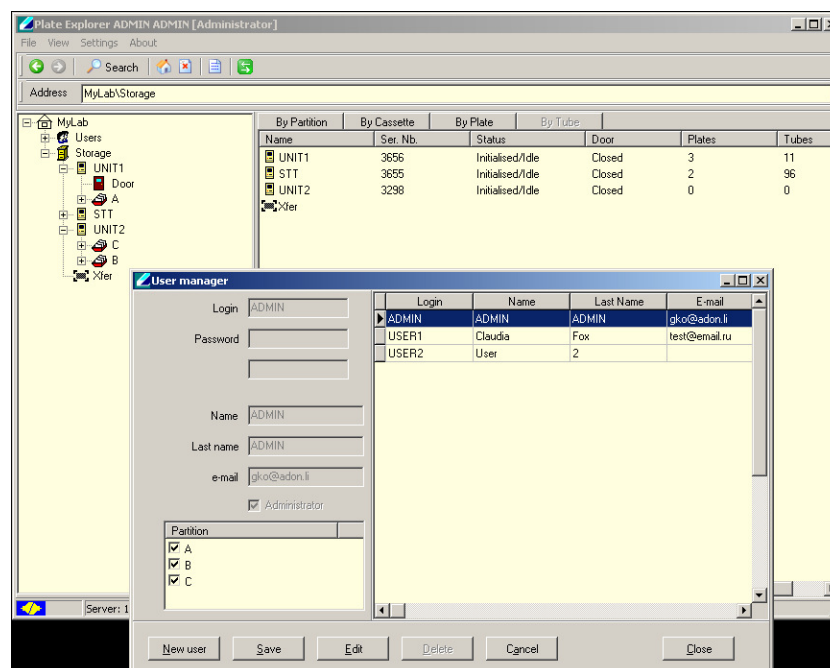

Picture 17: User Management

In order to set up a desired alarm notification, one needs to know that everyone who is marked as Administrator in this manager will get all error notifications under his or her given email address. Additionally the submitting users will get the alarms concerning their jobs.

Partitioning

Depending on the use of the system different partitions can be created. Partitions are virtual subdivisions and can be used to split the storage capacity for different uses, user groups or experiments. To launch the partition tool mark the storage unit with a left click, the right click the storage unit and select “Partition” in the menu. (Picture 18)

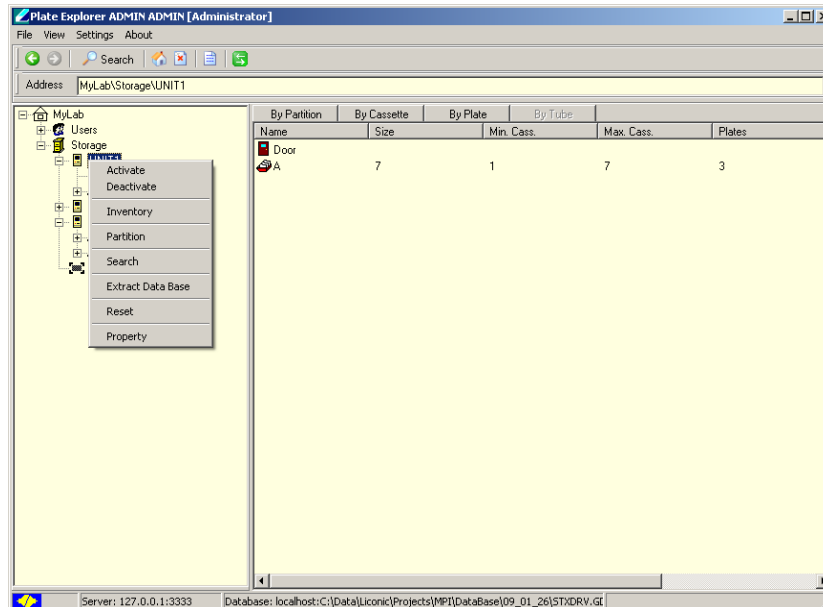

Picture 18: Accessing partition tool

The “Partition Master” will be started. A new partition can be created if free space is available, (white area on the top). Right click into the white area and select “New”. A dialogue box appears where the size of the partition can be entered.

Existing partitions can easily be manipulated by moving the mouse over the border of the partition to be changed. Hold down the left mouse button and move the mouse to the right to increase the size, move to the left to decrease the size.

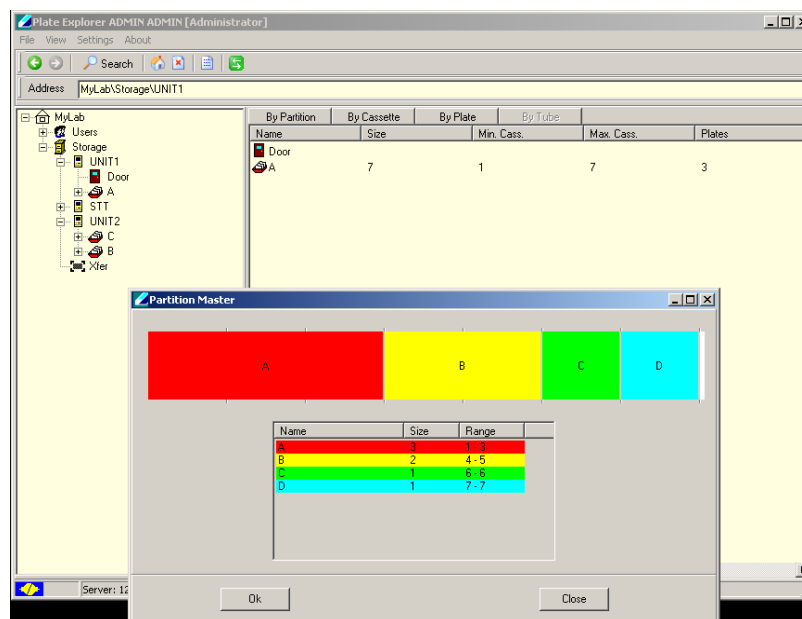

Picture 19: Creating / Modifying Partitions

16.3.4 Right-Click Action Menus in the Tree View

The right-click action menus are the most powerful tool within the PlateExplorer. They cover most of the commands and their content is depending on where they get activated.

Right-Click a “Device”

On the device level, the right-click menu offers the user to either “Search” within the device and its subunits or to show the devices “Properties” concerning storage capacity.

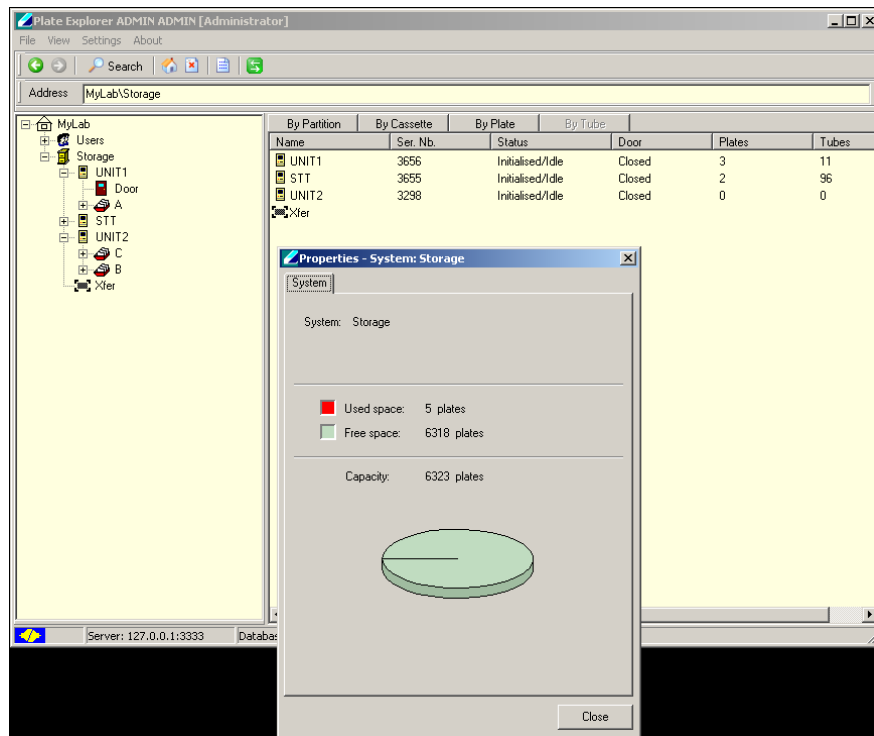

Picture 20: Device properties

Right-Click a “Unit”

When right-clicking a unit, a sub menu with seven items appears.

“Activate” and “Deactivate” open and close the communication with the clicked unit. If an error appeared before activation is pressed, the unit will reset and initialize. If no error happened before, it will only initialize.

“Partition” most likely will be used very seldom and is explained in this manual under 1.3.3 “Initializing the PlateExplorer”, sub item “Partitioning”.

“Search” will activate the search, described in chapter 1.3.2 “Layout of the PlateExplorer” in a way that only the clicked unit is searched.

“Extract database” will extract all relevant data from the database for this unit. A dialogue will be displayed that enables the user to create a file within a desired location.

“Reset” will simply reset the unit.

“Properties” is divided into several tabs. The tab Device shows the graphics with capacity used within the unit. Hardware deals with the settings for the COM-port of the unit, its firmware and its current status. Service enables the user to unload

a rack (current rack on the shovel to the Xfer station), using the belonging named button or to place a plate within the unit. The parameters (positions) are set in the belonging sub units of the functions. Additionally climate settings can be made here, possibly using the integrated alarm function by enabling it and setting a timeout value, for how long the unit is allowed to be out of the given boundaries.

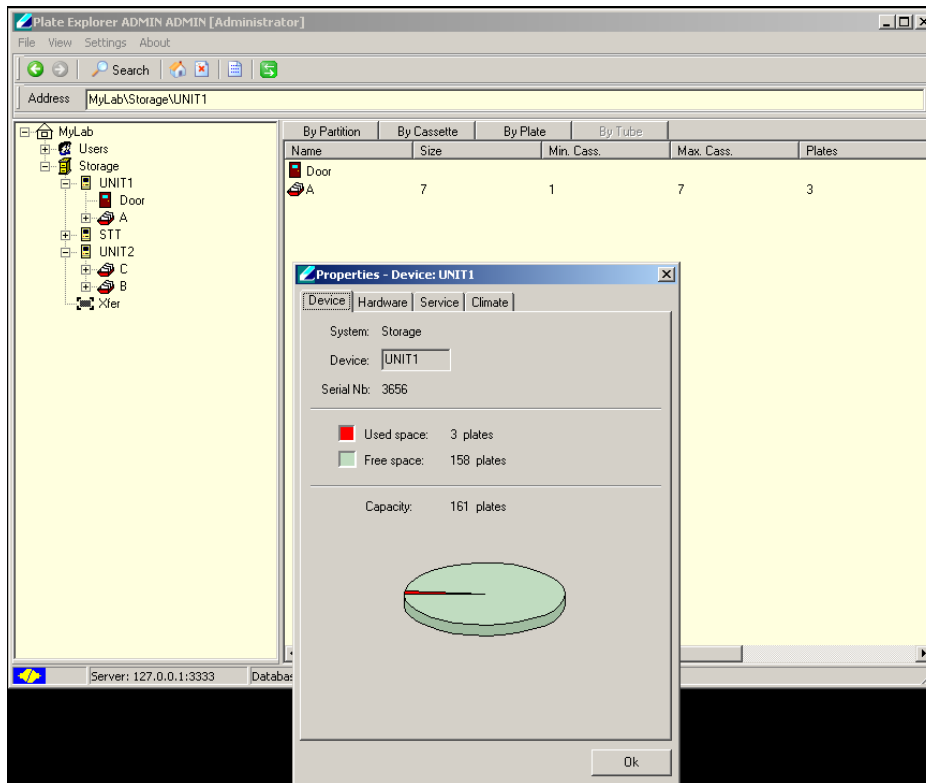

Picture 21: Unit properties

Right-Click a “Partition”

When right-clicking a partition, a sub menu with several options appears.

“Inventory” starts a 1D barcode inventory on the clicked partition :

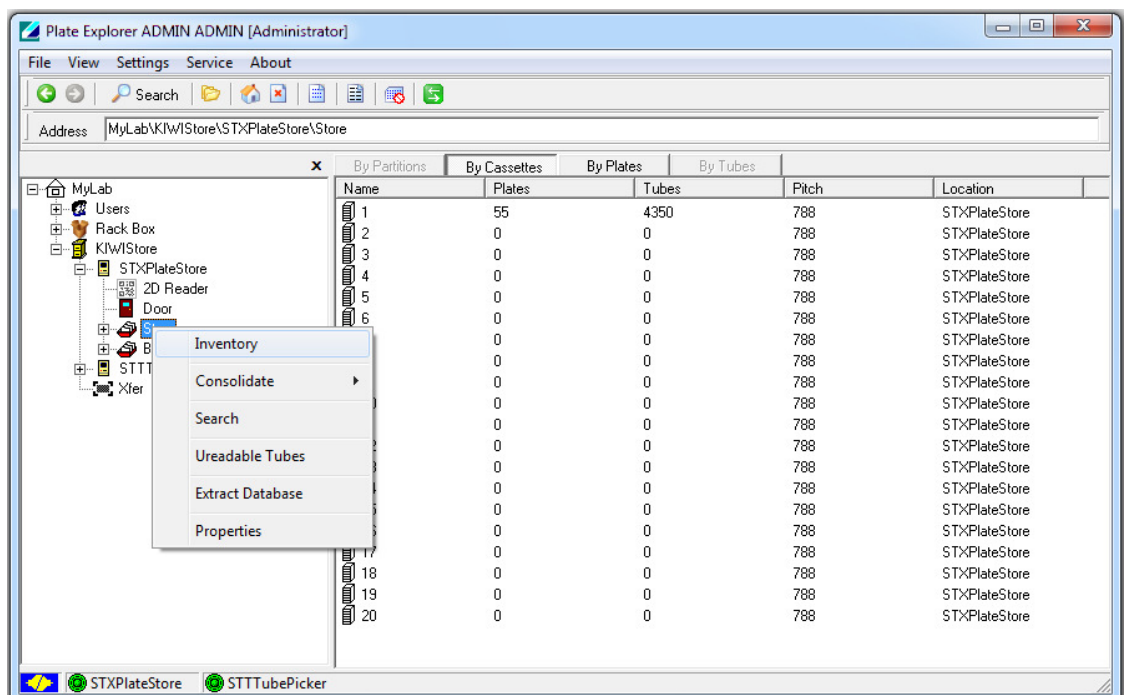

Use “Extract Database” function before and after “Inventory” to compare content of partition based on a CSV file if desired.

“Consolidate” starts a consolidation / defragmentation on the clicked partition :

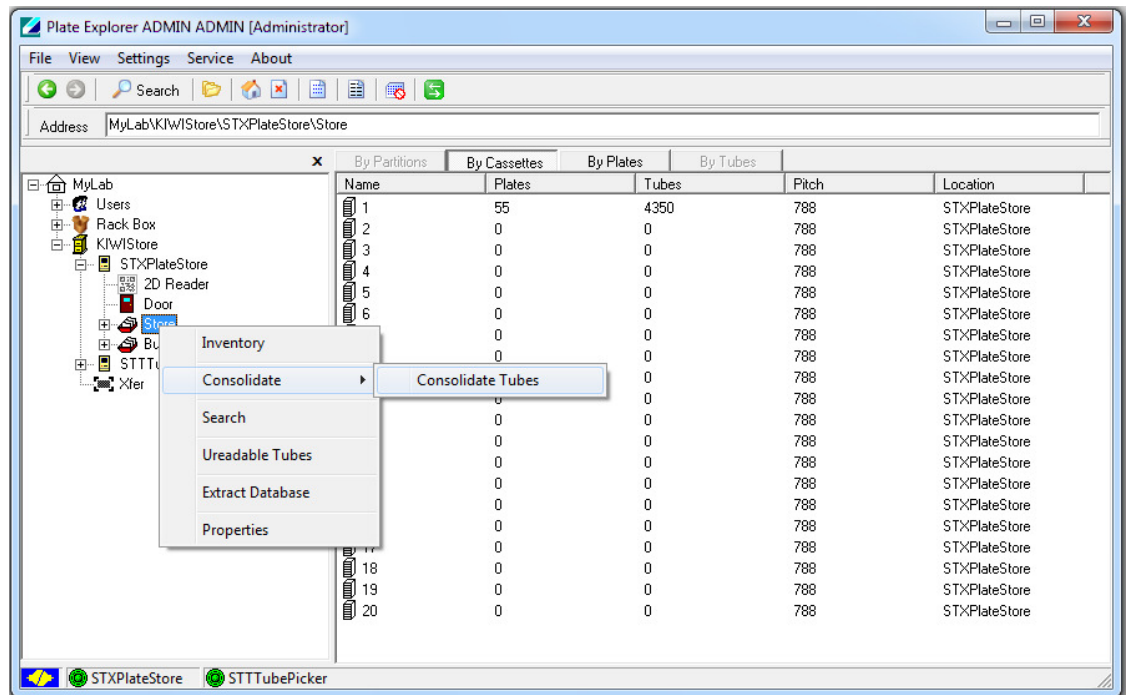

Use “Extract Database” function before and after “Consolidate” to compare content of partition based on a CSV file if desired.

“Search” opens the search interface, described earlier in 1.3.2 for only the partition selected.

“Unreadable vials” gives the user the opportunity to find not barcoded vials within the partition and create an unload-file from this list in order to check their codes.

“Extract database” will extract all relevant data from the database for this unit. A dialogue will be displayed that enables the user to create a file within a desired location.

“Properties” lets the user set some general properties and see the usage graph of the chosen partition.

Right-Click a “Cassette”

When right-clicking a cassette, there are two options to choose from:

“Search” opens the search interface, described earlier in 1.3.2 for only the cassette chosen.

“Properties” will show the usage graph of the clicked cassette and a check box to block the complete cassette for administrative reasons.

Right-Click a “Level”

When right-clicking a level, several options will appear:

“Copy” and “Paste” will enable the user to move plates within the system as described in 1.3.1. under “Using Drag&Drop and Copy&Paste”.

“Load” and “Unload” are direct access commands and will, when activated, immediately load a plate on the transfer station onto this level or unload the existing one onto the transfer station.

“Check Presence” and “Check Barcode” do what their names say. “Check Presence” will check the presence of a rack/plate on that level. “Check Barcode” will check the barcode of an existing plate or, if not identified yet, also check the presence of a plate on that level beforehand.

“Extract database” will extract all relevant data from the database for this unit. A dialogue will be displayed that enables the user to create a file within a desired location.

The “Properties” of a rack in a level lets under the tab “Plate” the user set the PlateID and see location information of the chosen Level. Under “Tubes” one can change the preset tube type and load content from an XML file. Additionally one can look at the history of the rack, the level and the content on the third tab.

If a level is clicked without a plate or rack being stored in it, the Properties only show the levels plate history and enable the user to close the level for administrative reasons.

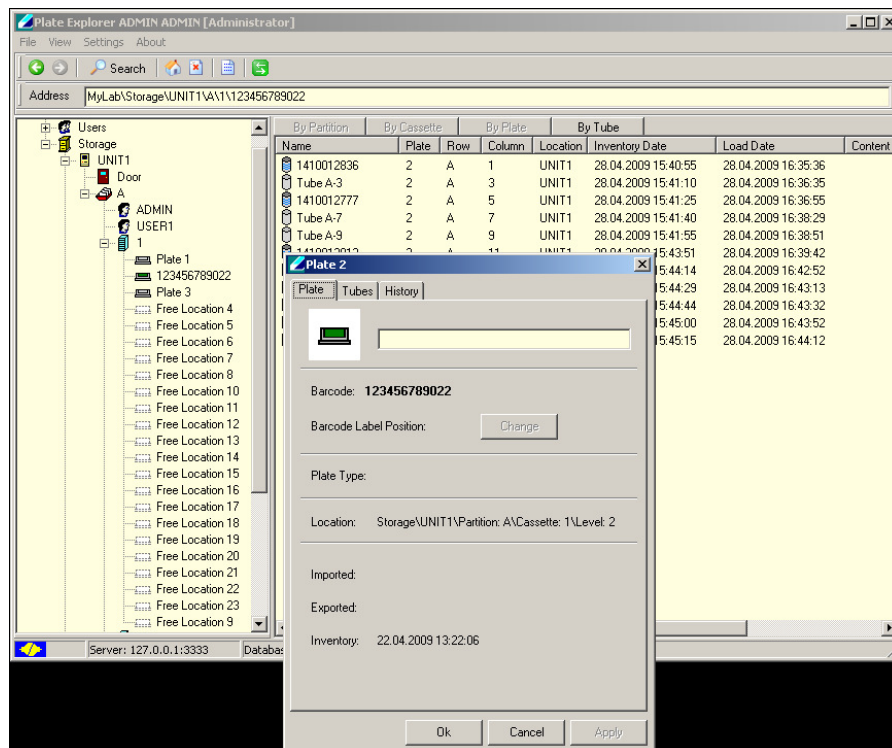

Picture 22: Plate/rack properties

16.3.5 Right-Click Action Menus in the Detail Information Screen

In the detailed information screen on the right, right-click menus are mostly the same as described for the tree view on the left. Additionally there are two extensions.

“Open in new window” opens the clicked item in a new window in order to be able to handle the shown items a bit more handy.

Additionally general tube “Properties”, like an ID, the mater, the concentration of the sample in the tube and the level of filling can be entered here.

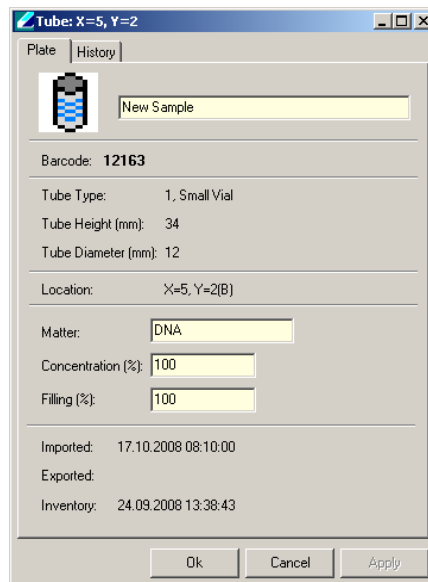

Picture 23: Tube properties

A simple history tracking is implemented for tubes as well as for plates and can be accessed via the sample properties. In the picture below, an example is shown.

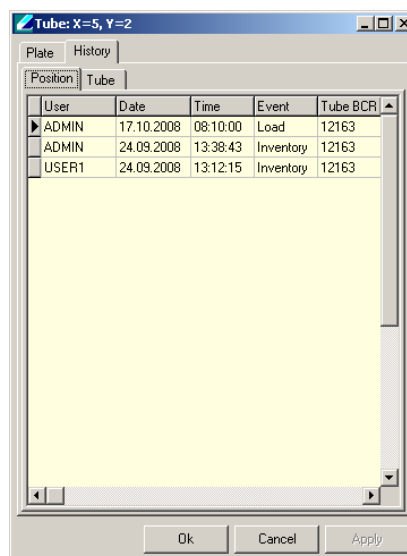

Picture 24: History

Having the occurrence of a plate being double in the system, the sub-tab “Content” in the history of the plate can be used to move the data from the old plate location to the new one. To do so, right-click the old plate and click “Select”

and then right-click the actual plate and click “Replace”. All data will be moved from the “Select”-plate to the “Replace”-plate then.

16.3.6 Right-Click Action Menus on the Boxer/Picker

The right-click menu on the tube separation unit covers the following items:

“Copy” and “Paste” enable the user to manually move tubes from plate to plate on the device. “Check Presence” will work only depending on the model of the picker/boxer. If integrated, the function checks if a tube exists on the clicked location within the rack. If possible with the purchased model “Check Barcode” will take the tube and read the 2D-code of a tube.

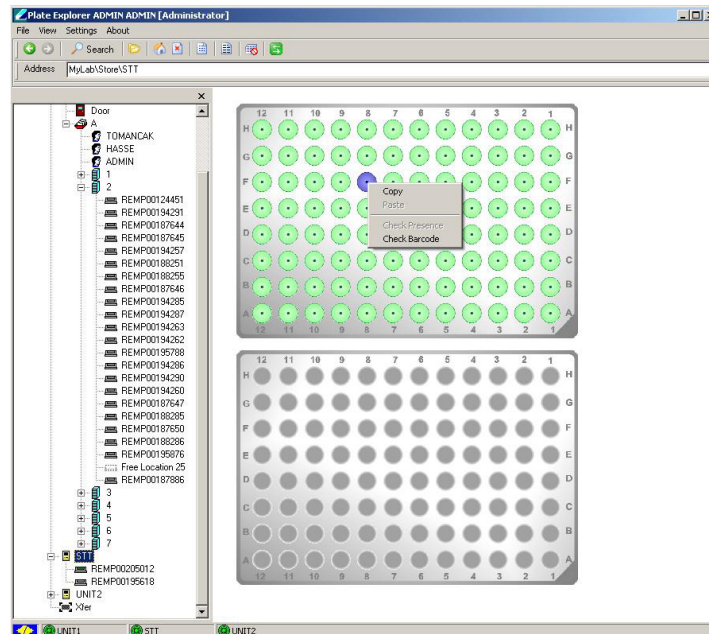

Picture 25: Right-click Menu of the Picker/Boxer

16.4 The Climate Explorer

Using the Climate Explorer enables the user to visualize the logged temperature data from the Kiwi devices database. The small tool consists of a menu bar, an area where one can choose the visualization options and the main graphics. The menu bar covers the following possibilities: File's "Exit" lets you exit the program. The Settings entry covers the choice of language; the databases path and the scale per unit (select the minimal and maximal value to be shown).



Picture 26: The Climate Explorers interface

The left part of the user interface controls the unit and the amount of time being displayed. First the user needs to choose the unit to be read out of the database. If current temperature is chosen, the graph will show a straight line on the level of the temperature being given in the device. Make sure that you have an adequate scale chosen in the settings menu. If day, month or history is chosen, the graph will show the progress of the temperature over the desired amount of time to be displayed. The show button actualizes the graphics.

17. Basic Configuration Files

All configuration files necessary are preset and delivered with the system. Modifications in the configuration files should only be performed after consultation of a Liconic applications specialist



CAUTION !

- Consult a Liconic specialist before changing the configuration files

The configuration files are present as “.LNI”-Files. The files can be opened and modified with a common text editor.

General Syntax:

```
//port=1234
```

Lines in a configuration file having a double slash (//) or an underscore (_) in front are ignored. They have no effect as they are commented.

17.1 Driver Configuration File: DriverConfig.Ini

The driver configuration file defines the parameters for the STXGui server. It is split in several sections which are described in the following parts.

17.1.1 Section: [TCP]

In this section the communication port and the communication log folder are set.

Syntax:

```
[TCP]
```

```
port=3333
```

```
LogFile=C:\STXTCPLog.log
```

Description:

Port: This Parameter defines the specific communication port set for all communication with the driver.

LogFile: A log file is created at the specified path to log all TCP communication to the driver.

17.1.2 Section: [WEB]

Setting for the web interfaces are made in this section.

Syntax:

[WEB]

port=81

Description:

Port: Web communication port to access the web interfaces.

17.1.3 Section: [XML]

Settings for the XML communication are located in this part of the configuration file.

Syntax:

[XML]

port=3334

Description:

Port: Setting of the communication port for the XML exchange.

17.1.4 Section [paths]

In this section the paths for several logging functions, system configuration and storage folders for optional functions are set.

Syntax:

[paths]

StxMainFolder=D:\Liconic

CommunicationLogFolder=D:\Liconic\Log

LowLevelCommunicationLogFolder=D:\Liconic\LogLowLevel

PickBackJobFolder=D:\Liconic\PickBackJob

PickJobReportFolder=D:\Liconic\PickJobReport

XMLContent=D:\Liconic\XMLContent

XMLCommunicationLogFolder=D:\Liconic\XMLLog

ZiathTextContent=D:\ziath-csv

InXMLEventsFolder=D:\Liconic\Events\In

OutXMLEventsFolder=D:\Liconic\Events\Out

PickJobReportFolder=D:\Liconic\PickJobReport

Description:

- STXMainFolder:** Path to the main folder. In this folder the software and the system configuration is located.
- CommunicationLogFolder:** In this folder the high level string commands are logged which are sent to the STXGui Server.
- LowLevelCommunicationLogFolder:** In this set folder the low level communication is logged, being sent from the STXGui server to the hardware.
- PickBackJobFolder:** In this set folder pick back job files, being created by the LiCONiC software, are stored.
- XMLContent:** In this set folder Upload-data for the LiCONiC software can be placed. It is read out if an inventory of the buffer is started.
- XMLCommunicationLogFolder:** In this set folder the LiCONiC drivers XML communication is logged.
- ZiathTextContent:** If installed, this is the set folder the driver is permanently looking for Ziath import files.
- InXMLEventsFolder:** This folder is set as the input-folder for a bridge between the LiCONiC software and special LIMS adapters. For further information using this special solution, please contact your local LiCONiC representative.
- OutXMLEventsFolder:** This folder is set as the output-folder for a bridge between the LiCONiC software and special LIMS adapters. For further information using this special solution, please contact your local LiCONiC representative.
- PickJobReportFolder:** Set folder for where the results of pickjobs can be accessed in a CSV-format.

17.1.5 Section: [database]

In this section the storage location, the belonging network server and the embedded property of the database is stored.

Syntax:

[database]

server=localhost

path=D:\Liconic\DB\STXDRV.GDB

Embedded=0

Description:

Server: Address of server where the database is located.

- localhost: The database is located on the same computer as the actual driver controlling the system.
- IP-Address: For a database located on a remote server an IP-address or alternatively a DNS or NetBIOS host name has to be given

path: Path of the actual database file either on the PC the driver is running on (in case of localhost) or on the server (in case of a network configuration).

Embedded: For systems with low storage capacity an embedded database is available with limited functionality. This can be enabled here.

17.1.6 Section: [Options]

In this section optional functions offered are enabled or disabled.

Syntax:

[Options]

ShowErrorMessage=0

DevicesLogFile=D:\Liconic\DevError.log

KeepHistory=1

SimulationMode=0

KeepEventsHistory=0

PickingTubesVerify=1

SortByAlley=0

MissingTubesProceed=1

MismatchPickBack=1

RackBCPickingTubesVerify=0

PickingTubesUnloadBack=1

Description:

ShowErrorMessage:	Switch on/off the message displaying function in case of an error.
DevicesLogFiles:	Path to the folder where errors of the devices are logged.
KeepHistory:	Enabling/Disabling history tracking
SimulationMode:	Enables/Disables the simulation mode of the STXGui server for software and communication development.
KeepEventsHistory:	Enabling/Disabling event tracking via the In-/ OutXMLEventsFolder.
PickingTubesVerify:	Enables/Disables the 2D-tube code verification during picking.
SortByAlley:	This parameter can be used for systems with double transfer stations in order to enable a sorting of the source racks by alley within the -80°C part of the STC devices.
MissingTubesProceed:	Enables/Disables proceeding of a pick job and updating the database in case of missing tubes (tubes not available for picking). If set to 0

the system will stop and send an error message via email.

MismatchPickBack: Enable/Disable tubes to be returned to its original position in case of mismatched 2D tube code reading (only working in combination with a TubePicker and enabled RackPickingTubesVerify).

RackBCPickingTubesVerify: Enable/Disable 1D rack code verification. The 1D rack code is read prior to the transport of the rack to be picked out of or into.

PickingTubesUnloadBack: This option enables the user to force the system to move racks being taken from the device back to their exact original position (cassettes, level) within the devices.

17.1.7 Section: [Messages]

In this section parameters are defined for transmitting messages from the system.

Syntax:

[Messages]

SendMessages=0

SMTPAddress=mail.srg.li

SMTPPort=25

From=XYZ@SRG.de

Description:

SendMessages: Enables/Disables the email message transmission.

SMTPAddress: Address of the SMTP server used to transmit the messages.

SMTPPort: Communication port of the SMTP server.

From: Set name for the notification mail sender.

17.2 System Configuration File: System.Ini

In the main folder defined in the DriverConfig.Ini the System.Ini configuration file is found containing the combination of the individual units to a system.

17.2.1 Section: [System]

In this section the system identification and the displayed name (in the User interfaces) is set.

Syntax:

```
[System]

SystemName=Storage

SystemId=Storage
```

Description:

SystemName: Definition of the display name of the system.

SystemId: Definition of the system id used for commands addressed to the system as a whole.

17.2.2 Section: [Unit]

In this section the units the system consists of are defined.

Syntax:

```
[Unit]

Unit1=Store.lni

Unit2=Boxer.lni

Unit3=Interface.lni
```

Description:

UnitX: Definition of configuration files belonging to the individual devices a system does consist of. This is strongly dependent on the specifics of the system.

18. Unit Configuration File Types

18.1 Common Sections

This section is part of all unit configuration files.

18.1.1 Section: [Unit]

In this section the basic communication settings and parameter file settings are made.

Syntax:

```
[Unit]
```

```
UnitComPort=3
```

```
UnitBCRPort=4
```

Description:

UnitComPort: Here the Units COM port for general interaction with the device is set.

UnitBCRPort: Here the COM-port of the 1D barcode reader is set.

18.1.2 Section: [ParameterFile]

Here the name of the sub units parameter file is set.

Syntax:

```
[ParameterFile]
```

```
FileName=Param.txt
```

Description:

FileName: Defines the filename to be used for reading out DM parameters of this sub unit. In order to change those, please consult a LiCONiC representative.

18.2 STC Store configuration File: Store.Ini

This section describes the setting file of an STC unit.

18.2.1 Section: [Climate]

Here the climate type is set.

Syntax:

```
[Climate]
```

```
ClimateType=DF
```

Description:

FileName: Defines the climate type of the sub unit. This option is not activated by LiCONiC yet.

18.2.2 Section: [Options]

Here options of the unit are set.

Syntax:

```
[Options]
```

```
XFerStation=0
```

```
Storage=1
```

```
SysStat=1
```

Description:

XFerStation: Defines the presence/absence of a transfer station.

Storage: This is the attribute that assigns the device type to the belonging unit.

SysStat: If implemented in the Firmware and set to 1, this attribute enables the Administrator of the system to request a deeper level of information by an extended command result.

18.2.3 Section: [Option Configuration]

Here further options for the unit are set.

Syntax:

```
[Option Configuration]
```

```
Door=0
```

```
DoubleIntXFerStation=0
```

```
NeighbourPlate=0
```

```
UseFirstAlleyExchange=1
```

Description:

Door: Sets the presence/absence of a door in the belonging sub unit.

DoubleIntXFerStation: Sets the presence/absence of a double internal transfer station in the belonging sub unit.

NeighbourPlate: Enables the system to keep the current position after movements within the unit. This should only be switched on or off after talking back to a LiCONiC representative.

UseFirstAlleyExchange: This option enables the device to already open the gate, when the handling arrives in the alley of the internal transfer. **This is only possible if your device has the internal transfer station within the first alley.**

18.2.4 Section: [Option Configuration2]

Here a second parameter set for the unit is set.

Syntax:

```
[Option Configuration2]
```

```
BCR=1
```

```
Compatibility=6
```

Description:

BCR: The attribute sets the presence/absence of a 1D barcode reader in the belonging unit.

Compatibility: This attribute is set by LiCONiC representatives in order to set firmware version compatibility and should not be changed under all circumstances.

18.2.5 Section: [Sensor Configuration]

Here the configuration of the sensors is set.

Syntax:

```
[Sensor Configuration]
```

```
PlatePresenceSensor=1
```

```
pShovelSen=1
```

```
pxferSens1=0
```

Description:

PlatePresenceSensor: Parameter to switch on and off the usage of the plate presence sensor.

pShovelSen: Parameter to switch on and off the usage of the shovel sensor.

pxferSens1: Parameter to switch on and off the usage of the plate presence sensor on internal double transfer stations.

18.2.6 Section: [Carousel Configuration]

Here the parameter for the integrated carousel is set.

Syntax:

```
[Carousel Configuration]
```

```
ManualAccessOffset=3
```

Description:

ManualAccessOffset: This is a special parameter for the StoreX systems in order to manipulate the position of cassettes for manual access. If you want to use that parameter please talk back a LiCONiC representative.

18.2.7 Section: [Climate Configuration]

Here the climates configuration settings are made.

Syntax:

[Climate Configuration]

Temperature=1

Humidity=1

MinTemperature=-90

MaxTemperature=-70

TimeOutTemperature=2

MinHumidity=21

MaxHumidity=90

TimeOutHumidity=3

TemperatureAlarm=1

HumidityAlarm=0

Description:

Temperature:	Activates/Deactivate the temperature control.
Humidity:	Activates the humidity control.
MinTemperature:	Sets the lower alarm value for the temperature.
MaxTemperature:	Sets the upper alarm value for the temperature.
TimeOutTemperature:	This value tells the maximum amount of time the set temperature can be out of the given limits.
MinHumidity:	Sets the lower alarm value for the humidity.
MaxHumidity:	Sets the upper alarm value for the humidity.
TimeOutHumidity:	This value tells the maximum amount of time the set humidity can be out of the given limits.
TemperatureAlarm:	Activates the Alarm messaging for the temperature monitoring.
HumidityAlarm:	Activates the Alarm messaging for the temperature monitoring.

18.2.8 Section: [Partitions]

In this section the settings for the partitions within the unit are made.

Syntax:

```
[Partitions]
```

```
B=1
```

Description:

This parameter is a special parameter used for specific systems. If your system applies to having that and you want to change it, please contact a LiCONiC representative.

18.2.9 Section: [CassettesConfiguration]

In this section the usage of a cassette configuration table is decided and pitch heights as well as amounts of levels are assigned to the cassettes.

Syntax:

```
[Cassette Configuration]
```

```
UseCassConfTable=0
```

```
1-140=44,1918
```

Description:

UseCassConfTable: Activates the usage of the cassette configuration table being given in XXX. The lines below mark the different configuration setting areas with their amounts of levels and the assigned pitch height.

18.2.10 Section: [X-Tilt] – some old systems – liconic tech

In special systems this parameter section assigns X-tilt values to specific cassettes.

18.3 Interface Configuration File: Interface.Ini

This section shows the configuration options of a unit file for an STC interface unit.

18.3.1 Section: [Options]

In this section the usage of different options is set.

Syntax:

[Options]

XFerStation=1

DoubleDeck=0

Peripheral=1

Handshake=0

SysStat=0

Description:

XFerStation: Regulates the presence/absence of a transfer station for the unit.

DoubleDeck: This parameter regulates the presence/absence of a second cassette level in the unit.

Peripheral: Sets the attribute for the main device for the customer interaction.

Handshake: This technical parameter synchronizes steps within movements. It should only be changed by a LiCONiC representative.

SysStat: If implemented in the Firmware and set to 1, this attribute enables the Administrator of the system to request a deeper level of information by an extended command result.

18.3.2 Section: [Option Configuration]

In this section the usage of different options is set.

Syntax:

```
[Option Configuration]
```

```
Door=1
```

```
InventoryContent=0
```

```
CloseDoorAutoInventory=0
```

Description:

Door: Defines the presence/absence of a door in the unit.

InventoryContent: Enables a complete 2D-code check when a tube rack enters the system via the transfer station. This will only work in combination with the CloseDoorAutoInventory enabled.

CloseDoorAutoInventory: Activates the automatic 1D-code inventory of the unit when the door gets closed.

18.3.3 Section: [Option Configuration2]

In this section the usage of different options is set.

Syntax:

```
[Option Configuration2]
```

```
BCR=1
```

```
Compatibility=6
```

```
LoadPlateBack=0
```

Description:

BCR: The attribute sets the presence/absence of a 1D barcode reader in the belonging unit.

Compatibility: This attribute is set by LiCONiC representatives in order to set firmware version compatibility and should not be changed under all circumstances.

LoadPlateBack: This feature enables the system delay of 2 minutes before a rack, when not being taken off the transfer station, is moved back into the system in order to protect its contents.

18.3.4 Section: [Sensor Configuration]

Here the configuration of the sensors is set.

Syntax:

```
[Sensor Configuration]
```

```
PlatePresenceSensor=1
```

```
pShovelSen=1
```

```
pxferSens1=1
```

Description:

PlatePresenceSensor: Parameter to switch on and off the usage of the plate presence sensor.

pShovelSen: Parameter to switch on and off the usage of the shovel sensor.

pxferSens1: Parameter to switch on and off the usage of the plate presence sensor on internal double transfer stations.

18.3.5 Section: [Carousel Configuration]

Here the parameter for the integrated carousel is set.

Syntax:

```
[Carousel Configuration]
```

```
ManualAccessOffset=5
```

Description:

ManualAccessOffset: This is a special parameter for the StoreX systems in order to manipulate the position of cassettes for manual access. If you want to use that parameter please talk back a LiCONiC representative.

18.3.6 Section: [Climate Configuration]

Here the climates configuration settings are made.

Syntax:

[Climate Configuration]

Temperature=1

Humidity=1

MinTemperature=-90

MaxTemperature=-70

TimeOutTemperature=2

MinHumidity=21

MaxHumidity=90

TimeOutHumidity=3

TemperatureAlarm=1

HumidityAlarm=0

Description:

Temperature:	Activates/Deactivate the temperature control.
Humidity:	Activates the humidity control.
MinTemperature:	Sets the lower alarm value for the temperature.
MaxTemperature:	Sets the upper alarm value for the temperature.
TimeOutTemperature:	This value tells the maximum amount of time the set temperature can be out of the given limits.
MinHumidity:	Sets the lower alarm value for the humidity.
MaxHumidity:	Sets the upper alarm value for the humidity.
TimeOutHumidity:	This value tells the maximum amount of time the set humidity can be out of the given limits.
TemperatureAlarm:	Activates the Alarm messaging for the temperature monitoring.
HumidityAlarm:	Activates the Alarm messaging for the temperature monitoring.

18.3.7 Section:[Partitions]

In this section the settings for the partitions within the unit are made.

Syntax:

```
[Partitions]
```

```
B=1
```

Description:

This parameter is a special parameter used for specific systems. If your system applies to having that and you want to change it, please contact a LiCONiC representative.

18.3.8 Section: [CassettesConfiguration]

In this section the usage of a cassette configuration table is decided and pitch heights as well as amounts of levels are assigned to the cassettes.

Syntax:

```
[Cassette Configuration]
```

```
UseCassConfTable=0
```

```
1-140=44,1918
```

Description:

UseCassConfTable: Activates the usage of the cassette configuration table being given in XXX. The lines below mark the different configuration setting areas with their amounts of levels and the assigned pitch height.

18.4 TubeBoxer/Picker Configuration File: Boxer.Ini

This section shows the configuration options of a unit file for a tube boxing unit.

18.4.1 Section: [Options]

In this section the settings for the tube picking/boxing units are made.

Syntax:

```
[Options]
STT=1
STTTYPE=1
STTPOS=1
STTMaster=UNIT1
UpHead=0
```

Description:

STT:	This parameter enables/disables the picker/boxer for the whole system.
STTTYPE:	This parameter sets the type of tube separation unit. 1=boxer, 0=picker
STTPOS:	This parameter describes the position of the picker within the interface (2nd cassette level).
STTMaster:	This parameter assigns the unit the picker/boxer is located in.
UpHead:	Enable this setting to take the boxer/picker head up (safe position) when plate is moved from/to the STT.

18.4.2 Section: [Option Configuration2]

Here further settings of the picker/boxer can be made.

Syntax:

```
[Option Configuration2]
BCR=1
```

Description:

BCR:	This setting enables/disables the 2D-reader on the picking unit.
------	--

18.4.3 Section: [TubesConfiguration]

This section contains the parameters of the tubes being used on the system.

Syntax:

```
[TubesConfiguration]
```

```
UseTubeHeight=0
```

```
Type 0=1620,12,8,0,0,0,0,0,0
```

Description:

UseTubeHeight: Enables/Disables the usage of tube types.

The lines below define the different tube types preset for the system. To extend the list, please contact a LiCONiC representative.

Trouble Shooting

19. Troubleshooting

The following chapter does give assistance to the customer to fix some errors which eventually could appear.

19.1 Basic Errors

The following table shows some basic errors of the Kiwi Stores which can be fixed by the customer. If the steps below aren't successful, please contact an authorized service person.



CAUTION !

- Never touch electrical connections as long the System is connected to the main power supply or one or more covers are removed.

Error	Cause	Action
Instrument does not power-up	Main Switch off circuit breaker or fuse in the power cabinet has tripped main inlet power source is not present	Turn Main Switch on Set back circuit breaker or replace fuses Check main inlet power source
System does not react on external commands	A fault in the electrical connectors/cables Wrong communication settings No communication to System Internal error	Check RS232 connections Check communication settings Check if software is running Call service personnel
System does not cool down	Cooling unit does not turn on	Check main power switch on cooling unit Call Service personnel
Cooling unit switches off shortly after it starts	Cooling unit break down Insufficient cooling media supply Insufficient coolant within system	Check cooling media supply Check coolant level Call service personnel
Handling stops with error	Error did appear	Check general handling error procedure for further steps

19.2 Error Listing

In this chapter all the possible errors codes which could arise in the system are listed, separated by device. The error codes are provided in PlateExplore as the hexadecimal number (column \$Hex), for manual Read out the decimal number (column #Dec) may be helpful.

Liconic provides an error converter tool. The errors may also be manually translated if the tool is unavailable. Therefore the following procedure may be used:

RD DM200 Read our error code with a suitable terminal program

The return value is a 5-digit decimal number. In order to get the error code this number needs to be converted into a hexadecimal number. The last two digits of the hexadecimal number is the error code. This code is referenced in the error lists of the following chapters.

19.2.1 STT1k5

#Dec	\$Hex	Description
01	01	General time out; Operation took longer than 15 Minutes
02	02	General time out; Time out after previous time out; Operation longer than 5 Minutes
03	03	Init time out; Initialization has taken to long
04	04	
05	05	
06	06	
07	07	Gate OPEN time out
08	08	Gate CLOSE time out
09	09	Lift travel exceeds maximum value
10	0A	Wrong Cassette; DM0 > DM29; Cassette number exceeds maximum cassette
11	0B	Lift overflow; travel path exceeds maximum allowed path
12	0C	Wrong Level; DM5 > DM25; Level does exceed the maximum available levels
13	0D	Plate trace Error; Plate was not loaded/unloaded as expected from/to shovel
14	0E	Init time out; System was not able to initialize
15	0F	
16	10	Turn in Turn Init Sensor or not in safe position; Possible step loss
17	11	
18	12	Carousel Init time out
19	13	Shovel OUT time out; shovel could not be extended
20	14	Shovel IN time out; Shovel could not be retracted

19.2.2 TubePicker

#Dec	\$Hex	Description
01	01	General time out; Operation took longer than 15 Minutes
02	02	General time out; Time out after previous time out; Operation longer than 5 Minutes
03	03	Init time out; Initialization has taken to long
04	04	
05	05	
06	06	
07	07	
08	08	
09	09	Tube Trace Error; Tube has not been taken into or moved out of gripper as expected
10	0A	Wrong Tube Y; DM5 > DM25; Cassette number exceeds maximum cassette
11	0B	
12	0C	Wrong Tube X; DM0 > DM29; Level does exceed the maximum available levels
13	0D	Plate trace Error; Plate was not loaded/unloaded to the Source/Target position
14	0E	Init time out; System was not able to initialize
15	0F	
16	10	Turn in Turn Init Sensor or not in safe position; Possible step loss
17	11	
18	12	Nest Init time out
19	13	
20	14	Shovel IN time out; Shovel could not be retracted
21	15	Emergency Stop; Swap head not ready
22	16	Swap head not in safe position
23	17	Plate Trace Error; plate on source position, no plate on Target position
24	18	Plate Trace Error; plate on target position, no plate on Source position
25	19	Plate Trace Error; no Plates on picker
26	1A	Boxer Error; Denied Command (Movement attempt in wrong direction)
27	1B	Head collision; head safe activated
28	1C	
29	1D	
30	1E	
31	1F	Diver safe not in expected state
88	58	Revolver not in expected position

19.3 Handling Errors

Some issues encountered while handling plates can be resolved by performing the procedures described in the following chapters. When performing these procedures, always carefully observe the moving of the robotics.

Should any mechanical resistance be observed while the robotics are moving, reset the system immediately and ask a trained engineer for assistance.

Should none of the procedures be of help, contact a Liconic trained engineer for further support.



CAUTION !

- When initializing the system after an error stop, check if the handler moves freely. Reset the system if this is not the case and ask for assistance.
- If you do not feel secure about performing the following tasks, ask your local engineer for assistance.
- When changing DM6 with the extended shovel, always be sure about the entered value as the handler will immediately move after sending the new value.

19.3.1 General

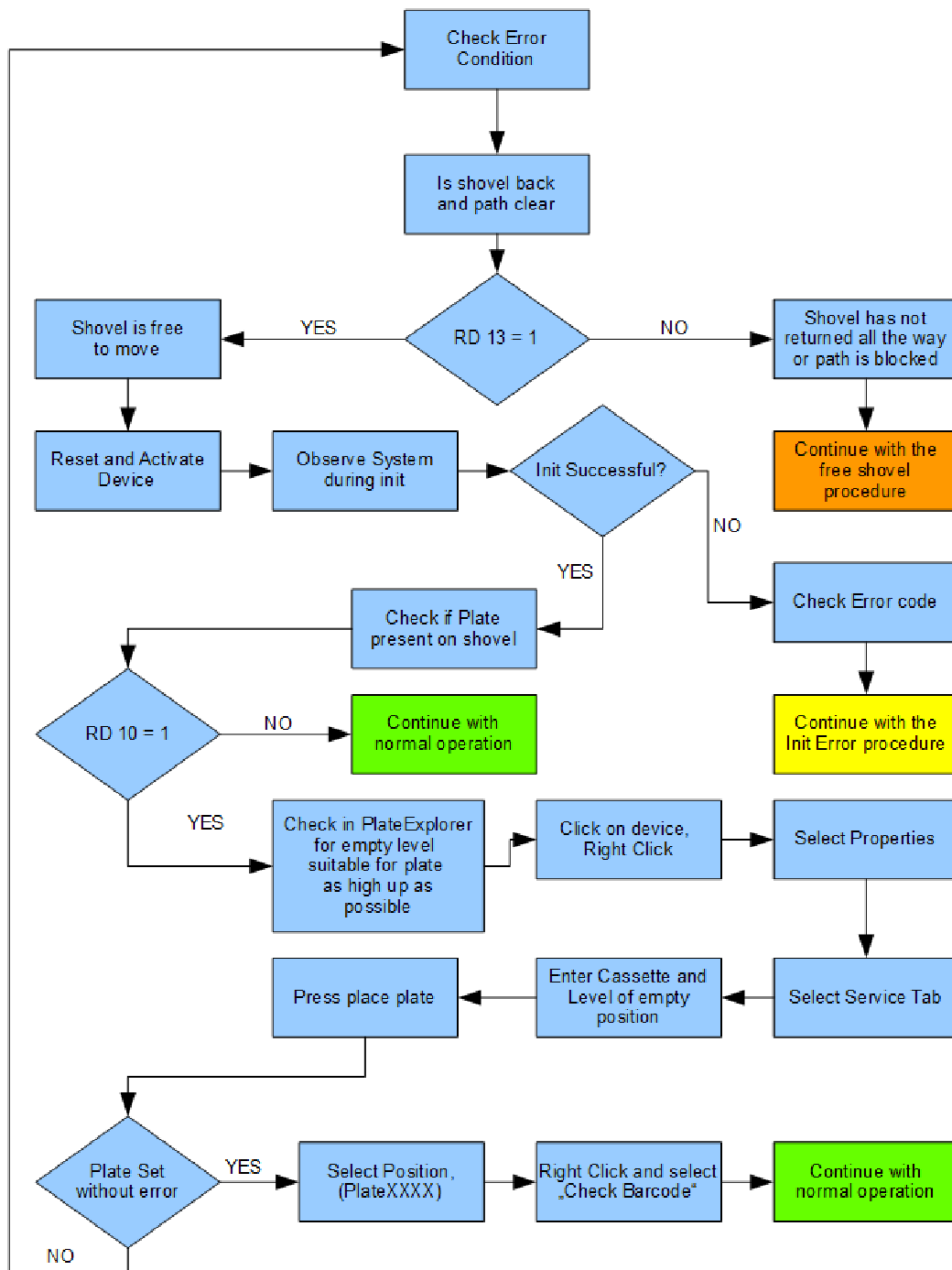

19.3.2 Free Shovel Procedure

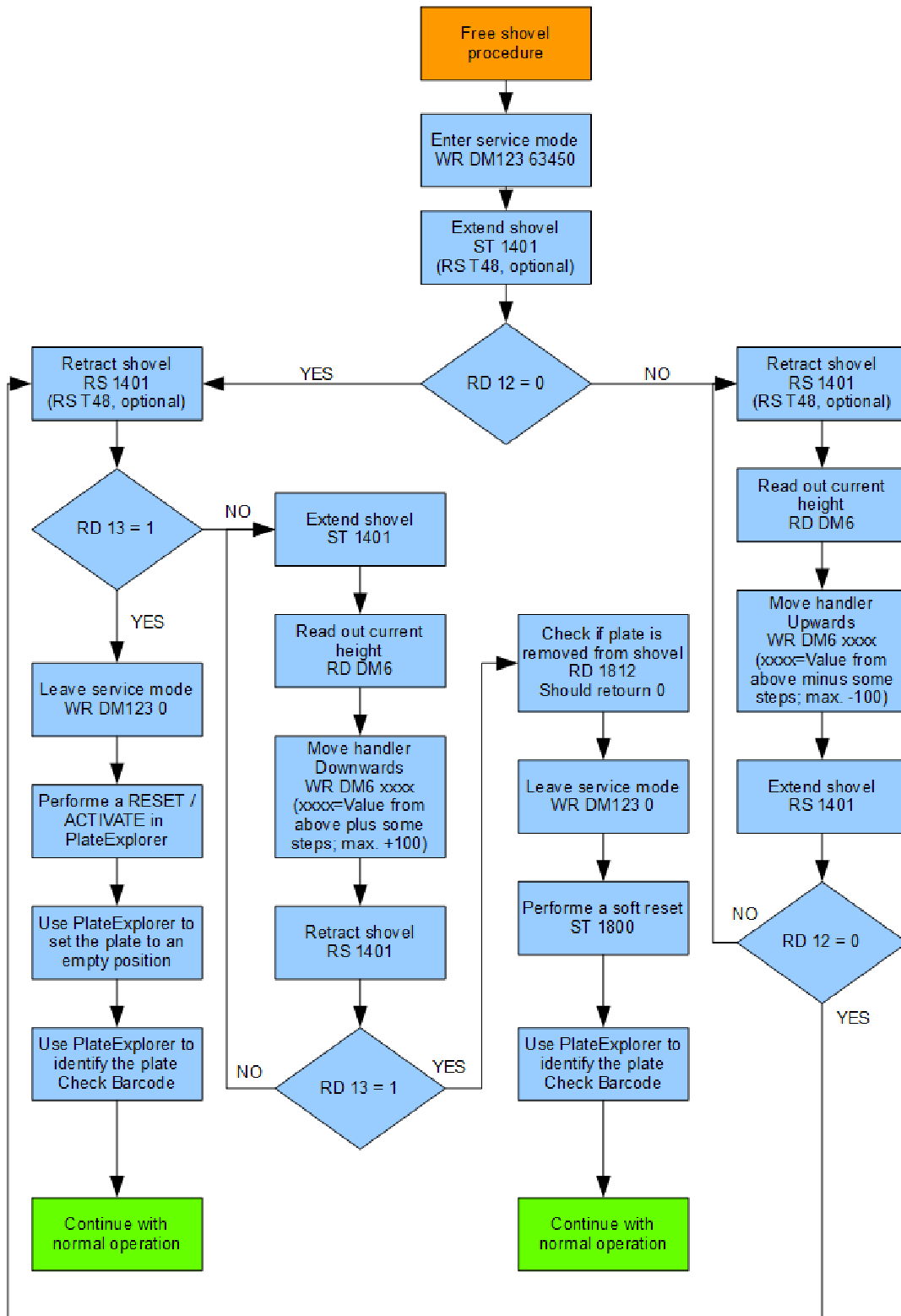

19.3.3 Init Error Analysis

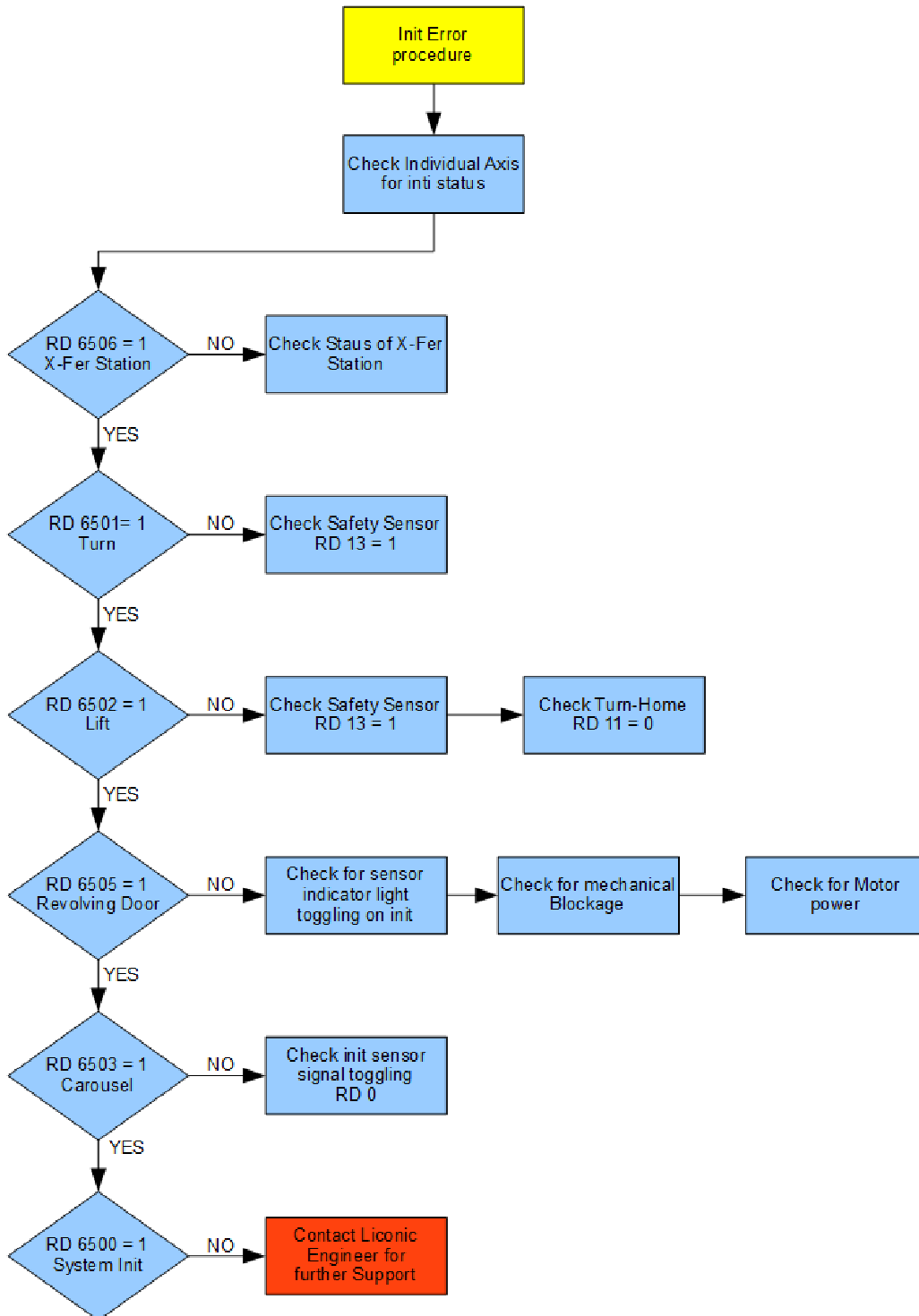

Safety Sheets

Safety guideline for the work in the service area of the LiCONiC STC-series

Works, that require the regulations:

maintenance (repair, maintenance, inspection), cleaning, hardware changes, disturbance removal

Behavior on the machine, that requires the regulations:

lean into the service area, get into / out of the service area, detention at the service area

Work on the device should only start following all given regulations in this document!

Potential danger	Protection mechanism
Contact with dangerous samples	<ul style="list-style-type: none"> • Additional to the usage of thermal protection clothing, please use Nitrile-gloves or gloves with comparable safety properties concerning dangerous materials • Check skin compatibility towards the used disposables
Lacking air condition / lack of oxygen (Measurement value <20,9%)	<ul style="list-style-type: none"> • For works within the area, a breathing mask is recommended (no Cartridge-mask, as this does not help). • Personal oxygen monitors have to be worn when entering the service area.
Burning skin by undercooling / freezing	<ul style="list-style-type: none"> • Generally only work in thermal protection clothing (thermally protect body, head and hands). Do not touch or pick up anything within the -80°C area without using tools. Never lean into the -80°C area under the isolation or step into it. Generally the work in the service area should be limited to 15 minutes time.
Violent pressure by mechanical parts	<ul style="list-style-type: none"> • Before entering the service area, switch off the device and put a sign, saying „Do not switch on device!“ on it. After the work a reset and re-initialization is necessary. Attention: Neither the cooling nor the handling should be switched off longer than 30 minutes!
Advanced physical stress by the small sizes of the service area.	<ul style="list-style-type: none"> • Duration of the work within the area should be limited to 15 minutes.

Bodily harm by sharp edges or corners (e.g. air condition pipes)	<ul style="list-style-type: none"> • Overtired or for different reasons unconcentrated persons should not do maintenance work.
suffocation / burning by contact with LN2	<ul style="list-style-type: none"> • When LN2 has been introduced into the system and the DEWAR needs to be exchanged, wear protective clothing. • In case no exhaust leading the N2 gas out of the room, only enter the room wearing a breathing mask with oxygen supply. • During operation of LN2 backup, do not touch any piping showing frost without protective clothing.
Bodily harm while entering the area by slipping off or falling down	<ul style="list-style-type: none"> • Access should only be realized with the help of proper tools, like a ladder
Contamination of the user by destroyed samples or of the probes by the user (product safety and personnel safety)	<ul style="list-style-type: none"> • To avoid a contamination of or by the samples, no sharp or acute tools should be used within the service area.

General Rules:

- 1) IF THERE ARE DOUBTS ABOUT THE FUNCTIONALITY OF THE DEVICE (FATIGUE, ABRASION OR BREAKING OF PARTS), THE USER SHOULD IMMEDIATELY ORDER A SERVICE BY LiCONiC AND THE USER SHOULD NOT ACCESS IT ANYMORE.
- 2) EVERY PERSON TAKING PART IN THE WORK ON THE DEVICE SHOULD BE INFORMED ABOUT THE SAFETY REGULATIONS BEFORE STARTING TO WORK. ONCE A YEAR AN ACTIVITY PLANNING SHOULD BE MADE WITH ALL PARTICIPATING PERSONS.